

# Chapter 2

# APPLICATIONS

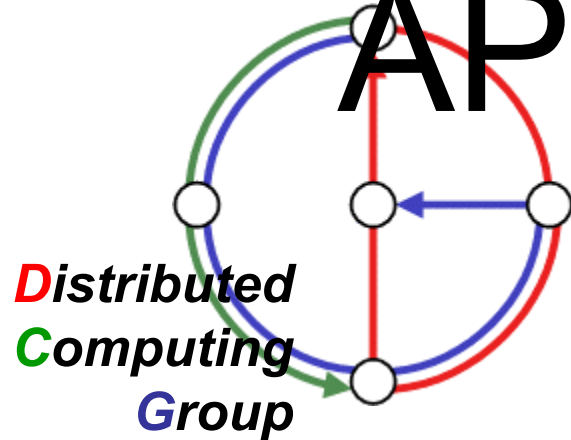

Computer Networks  
Winter 2002 / 2003

# Overview



- Learn specific application layer protocols
  - http, ftp, smtp, pop, dns, etc.
- How to program network applications?
- socket API for Java and Active Oberon
- Goals
  - learn about protocols by examining popular application-level protocols
  - Conceptual and implementation aspects of network application protocols
  - client-server paradigm
  - service models

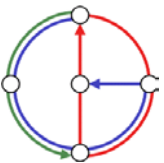

# Applications vs. Application-Layer Protocols

- Application: communicating, distributed process
  - running in network hosts in “user space”
  - exchange messages to implement application
  - e.g., email, ftp, web
- Application-layer protocol
  - one part of application
  - define messages exchanged by applications and actions taken
  - use communication services provided by transport layer protocols (TCP, UDP)

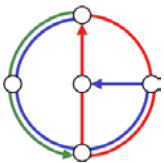
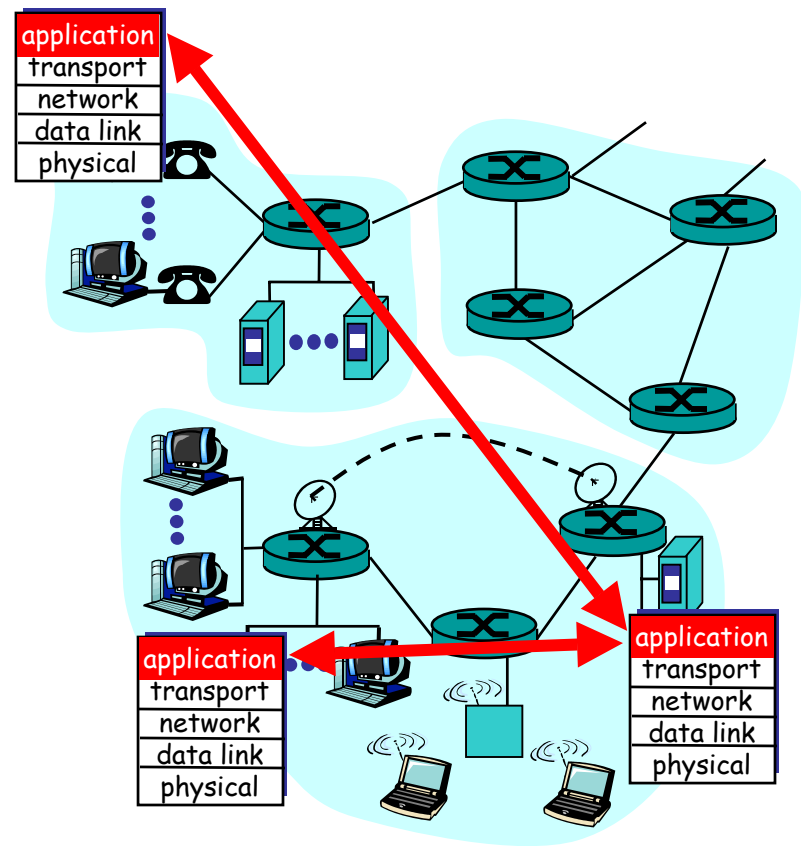

# Network applications: some jargon



- Process: program running within a host
  - within same host, two processes communicate using interprocess communication (defined by Operating System).
  - processes running on different hosts communicate with an application-layer protocol through messages
- User agent: software process, interfacing with user “above” and network “below”
  - implements application-level protocol
  - Examples
    - Web: browser
    - E-mail: mail reader
    - streaming audio/video: media player

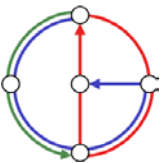

# Client-server paradigm

Typical network app has two parts: **Client** and **Server**

## Client

- initiates contact with server (“client speaks first”)
- typically requests service from server
- Web: client implemented in browser
- email: client in mail reader

## Server

- provides requested service to client
- e.g., Web server sends requested Web page, mail server delivers e-mail

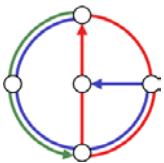
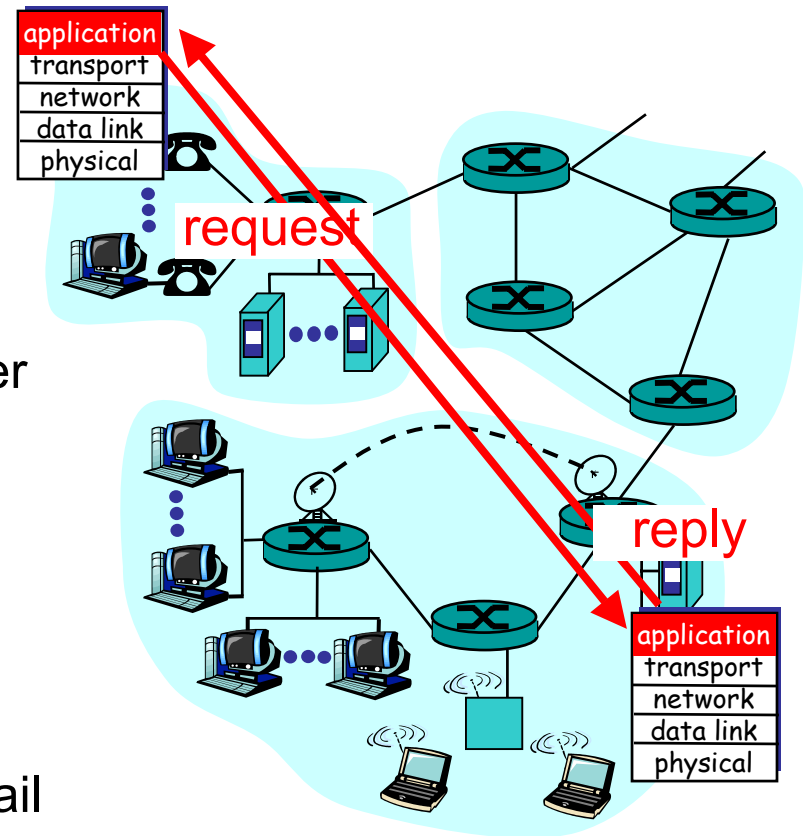

# API: Application Programming Interface



- Defines interface between application and transport layers
- socket: Internet API
- two processes communicate by sending data into socket, reading data out of socket
- How does a process identify the other process with which it wants to communicate?
  - IP address of host running other process
  - “port number”: allows receiving host to determine to which local process the message should be delivered
  - lots more on this later...

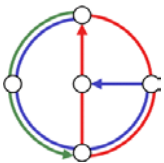

# What transport service does an application need?



## Data loss

- some apps (e.g. audio) can tolerate some loss
- other apps (e.g. file transfer) require 100% reliable data transfer

## Bandwidth

- some apps (e.g. multimedia) require minimum amount of bandwidth to be “effective”
- other apps (“elastic apps”) make use of whatever bandwidth they get

## Timing

- some apps (e.g. Internet telephony, interactive games) require low delay to be “effective”

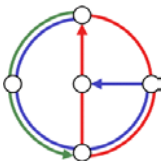

# Transport service requirements of common applications



<b>Application</b>	<b>Data loss</b>	<b>Bandwidth</b>	<b>Time Sensitive</b>
file transfer	no loss	elastic	no
e-mail	no loss	elastic	no
Web documents	loss-tolerant	elastic	no
real-time audio/video	loss-tolerant	audio: 5Kb-1Mb video: 10Kb-5Mb	yes, 100's msec
stored audio/video	loss-tolerant	same as above	yes, few secs
interactive games	loss-tolerant	few Kbps up	yes, 100's msec
financial apps	no loss	elastic	yes and no

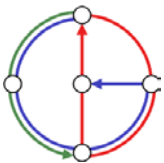



# Internet transport protocols services



## TCP service

- connection-oriented: setup required between client, server
- reliable transport between sending and receiving process
- flow control: sender won't overwhelm receiver
- congestion control: throttle sender when network overloaded
- does not provide timing, minimum bandwidth guarantees

## UDP service

- unreliable data transfer between sending and receiving process
- does not provide connection setup, reliability, flow control, congestion control, timing, or bandwidth guarantee
- Why bother? Why is there a UDP service at all?!?

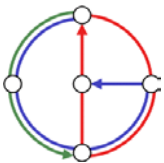

# Internet apps: application, transport protocols



<b>Application</b>	<b>Application layer protocol</b>	<b>Underlying transport protocol</b>
e-mail	smtp [RFC 821]	TCP
remote terminal access	telnet [RFC 854]	TCP
Web	http [RFC 2068]	TCP
file transfer	ftp [RFC 959]	TCP
streaming multimedia	proprietary (e.g. Quicktime)	TCP or UDP
remote file server	NSF	TCP or UDP
Internet telephony	proprietary (e.g. Vocaltec)	typically UDP

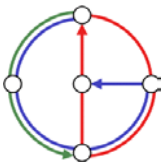

# The Web: The http protocol

## http: hypertext transfer protocol

- Web's application layer protocol
- client/server model
  - *client*: browser that requests, receives, and “displays” Web objects
  - *server*: Web server sends objects in response to requests
- http 1.0: RFC 1945
- http 1.1: RFC 2616

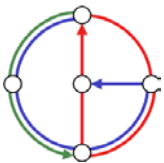
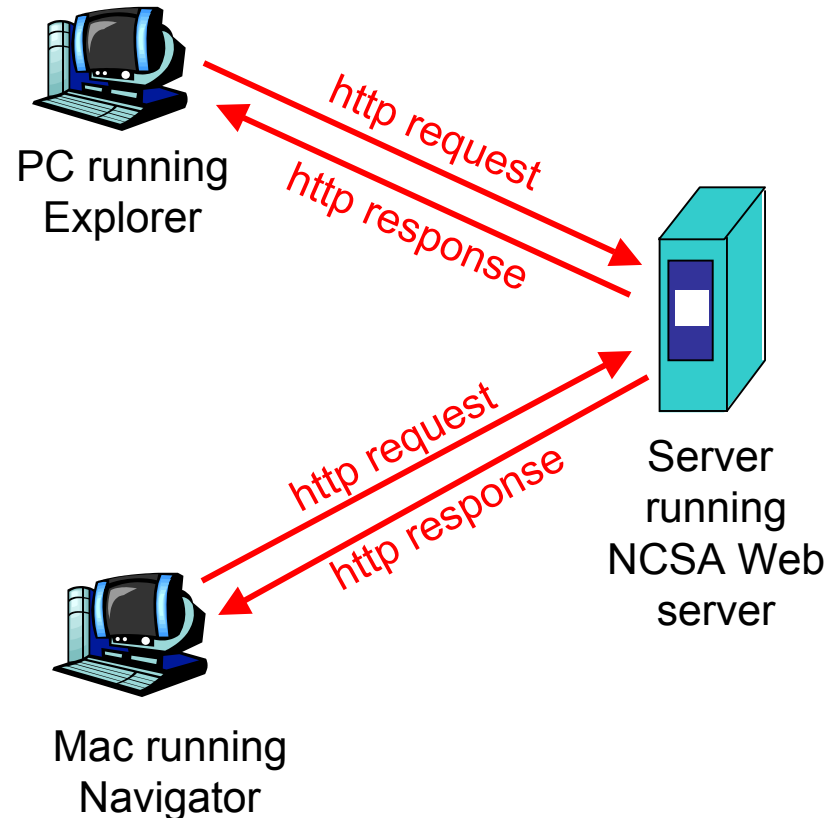

# More on the http protocol



- client initiates TCP connection (creates socket) to server, port 80
- server accepts TCP connection from client
- http messages (application-layer protocol messages) exchanged between browser (http client) and Web server (http server)
- TCP connection closed

## http is “stateless”

- server maintains no information about past client requests

- aside
- **Protocols that maintain “state” are complex!**
  - past history (state) must be maintained
  - if server/client crashes, their views of “state” may be inconsistent, must be reconciled

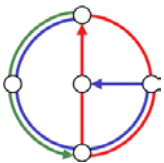

# Example for http



Suppose user enters URL `www.inf.ethz.ch/education/index.html`  
(assume that web page contains text, references to 10 jpeg images)

1. http client initiates TCP connection to http server (process) at `www.inf.ethz.ch`. Port 80 is default for http server.

2. http server at host `www.inf.ethz.ch` waiting for TCP connection at port 80, "accepts" connection, notifies client

3. http client sends http request message (containing URL) into TCP connection socket

4. http server receives request message, forms *response message* containing requested object (`index.html` in directory `education`), sends message into socket

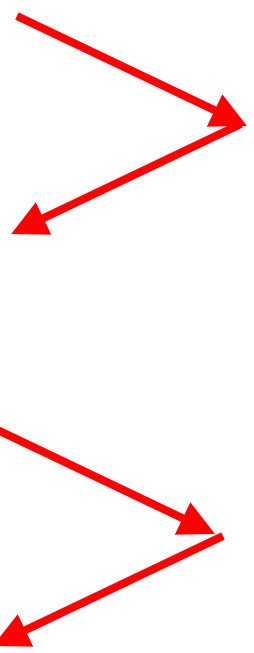

time

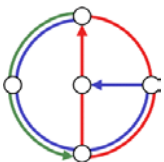

# Example for http (continued)



6. http client receives response message containing html file, displays html. Parsing html file, finds 10 referenced jpeg pictures

5. http server closes TCP connection



Then...

Steps 1-6 repeated for each of the 10 jpeg objects

time

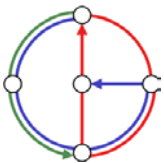

# Non-persistent vs. persistent connections



## Non-persistent

- http/1.0
- server parses request, responds, closes TCP connection
- 2 RTTs (round-trip-time) to fetch object
  - TCP connection
  - object request/transfer
- each transfer suffers from TCP's initially slow sending rate
- many browsers open multiple parallel connections

## Persistent

- default for http/1.1
- on same TCP connection: server, parses request, responds, parses new request,...
- client sends requests for all referenced objects as soon as it receives base HTML
- fewer RTTs, less slow start

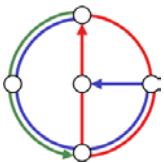

# http message format: request



- two types of http messages: *request*, *response*
- http request message: ASCII (human-readable format)

request line  
(GET, POST,  
HEAD commands)

header  
lines

GET /somedir/page.html HTTP/1.1  
Connection: close  
User-agent: Mozilla/4.0  
Accept-language: de

Carriage return  
and line feed  
indicate end  
of message

(extra carriage return, line feed)

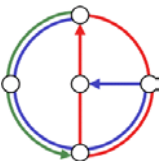



# http request message: the general format

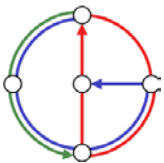
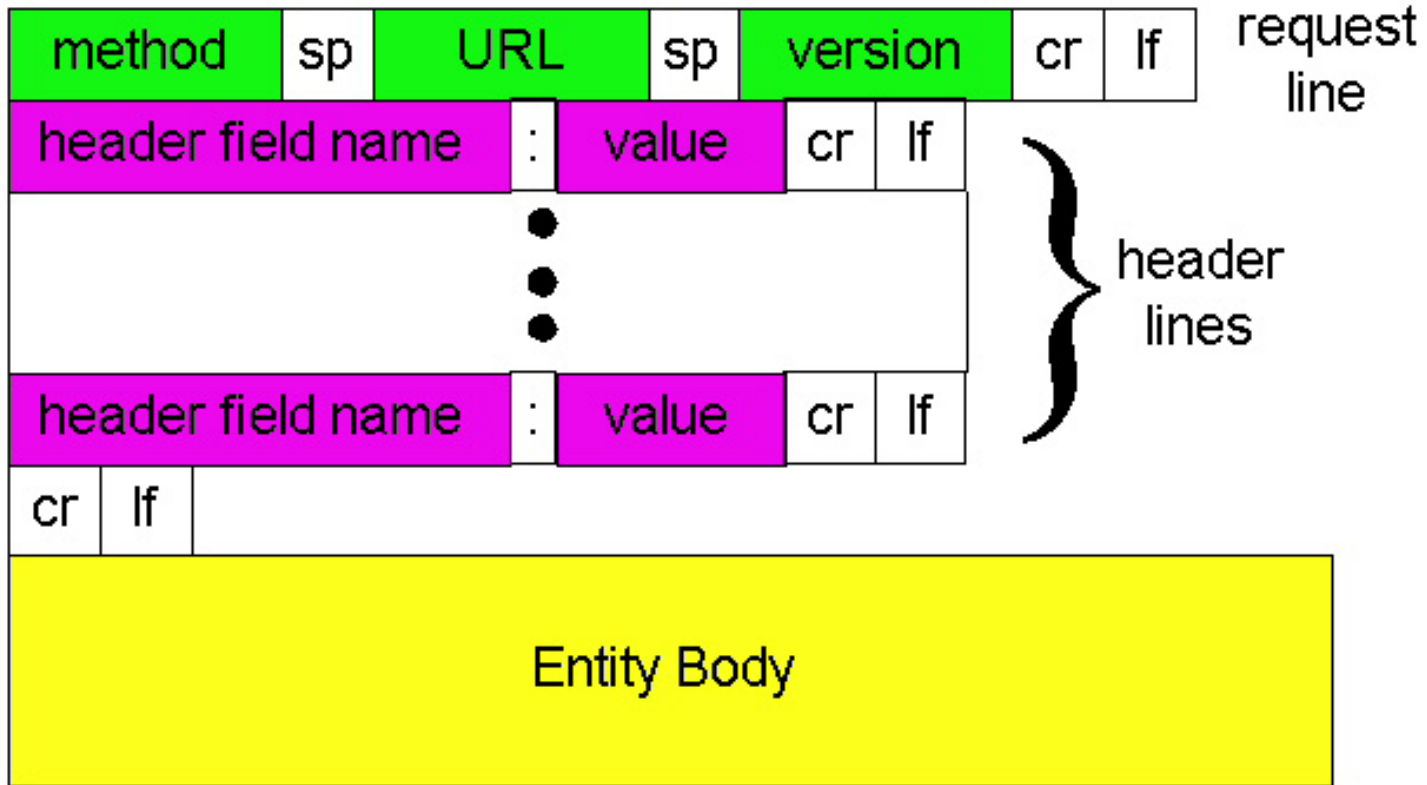

# http message format: response



status line  
(protocol  
status code  
status phrase)

header  
lines

HTTP/1.1 200 OK  
Date: Thu, 06 Aug 1998 12:00:15 GMT  
Server: Apache/1.3.0 (Unix)  
Last-Modified: Mon, 22 Jun 1998 ...  
Content-Length: 6821  
Content-Type: text/html

data, e.g.,  
requested  
html file

data data data data data ...

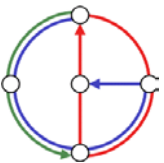

# http response status codes



First line of server→client response message.

A few sample codes:

## 200 OK

- request succeeded, requested object later in this message

## 301 Moved Permanently

- requested object moved, new location specified later in this message (Location:)

## 400 Bad Request

- request message not understood by server

## 404 Not Found

- requested document not found on this server

## 505 HTTP Version Not Supported

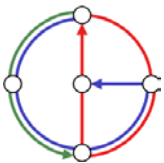

# Be your own http client



1. Telnet to your favorite Web server:  
`telnet www.sbb.ch 80`
  - Opens TCP connection to port 80 (default http server port) at www.sbb.ch.
2. Type in a GET http request:  
`GET /index.htm HTTP/1.0`
  - Anything typed in sent to port 80 at www.sbb.ch
  - By typing this (hit carriage return twice), you send this minimal (but complete) GET request to http server
3. Check out response message sent by http server...

Could you check the SBB timetable from within your own application?!?

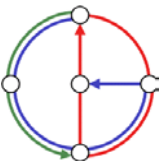

# User-server interaction: authentication



- Authentication: control access to server content
- authorization credentials: typically name and password
- stateless: client must present authorization in *each* request
  - authorization: header line in each request
  - if no authorization: header, server refuses access, sends

**WWW authenticate:**

header line in response

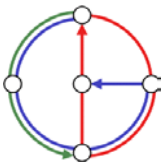
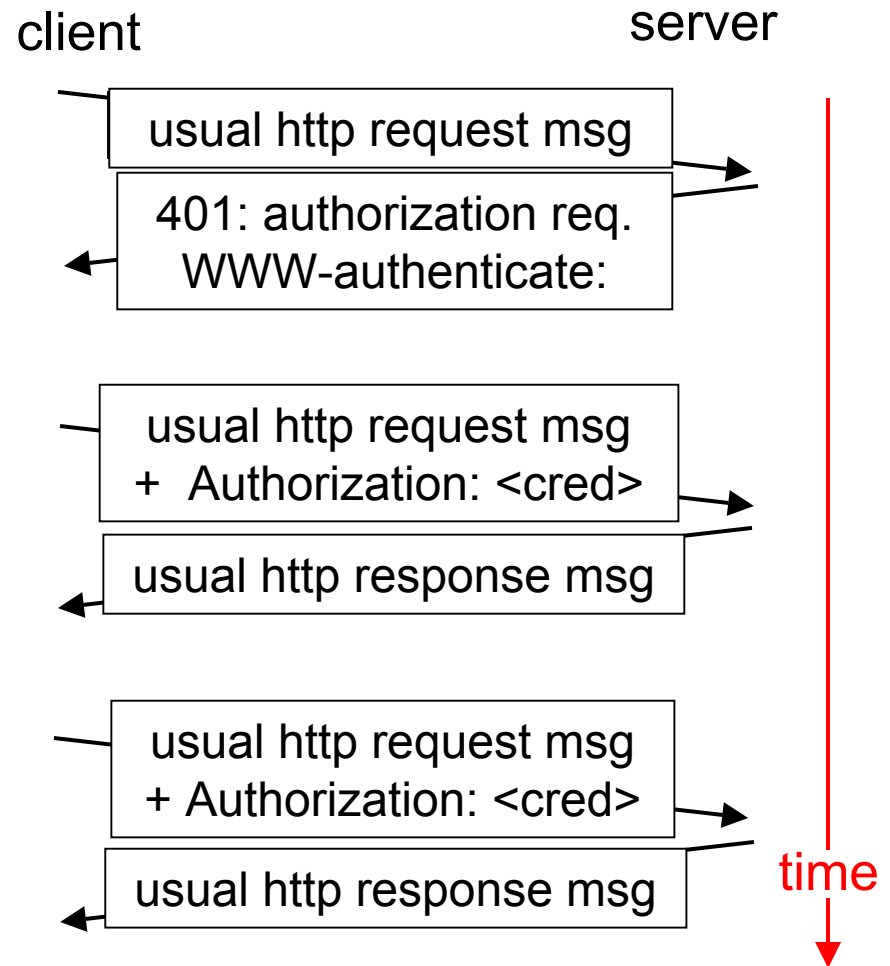

# Cookies: keeping “state”

- server-generated # , server-remembered #, later used for
  - authentication
  - remembering user preferences
  - remembering previous choices
  - (...privacy?)
- server sends “cookie” to client in response msg  
**Set-cookie: 1678453**
- client presents cookie in later requests  
**Cookie: 1678453**

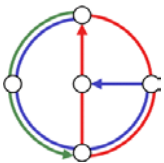
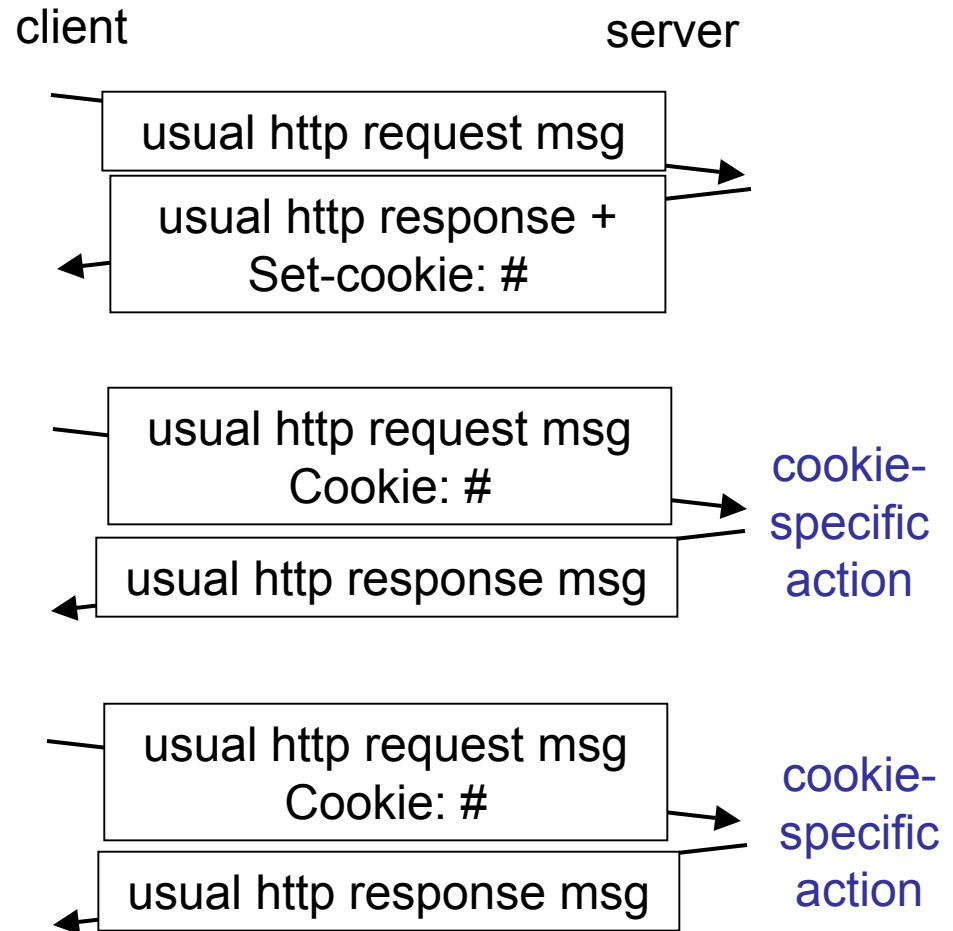

# Conditional GET: client-side caching



- Goal: don't send object if client has up-to-date cached version
- Client: specify date of cached copy in http request  
**If-modified-since: <date>**
- Server: response contains no object if cached copy is up-to-date:  
**HTTP/1.0 304 Not Modified**

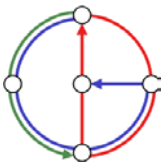
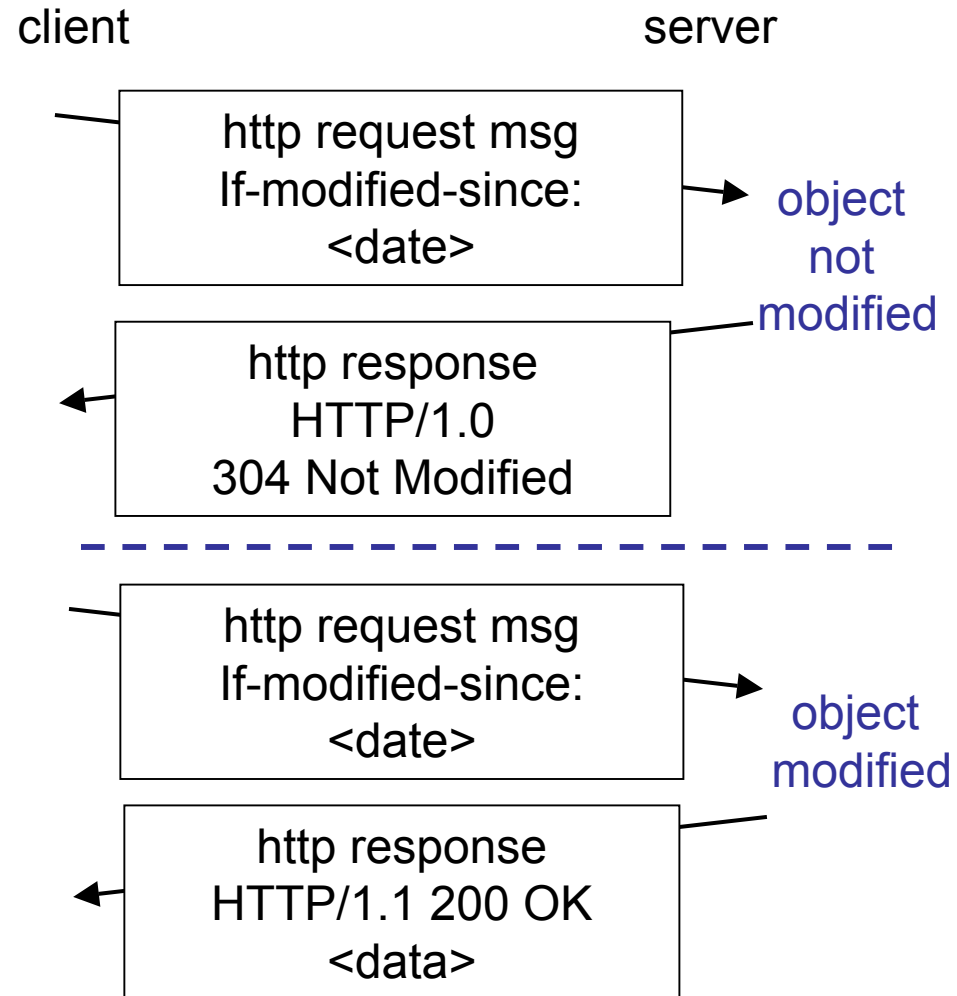

# Web Caches (a.k.a. proxy server)



- Goal: satisfy client request without involving origin server
- User sets browser: Web accesses via web cache
- client sends all http requests to web cache
  - object in web cache: web cache returns object
  - else web cache requests object from origin server, then returns object to client

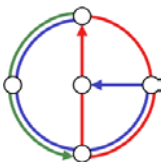
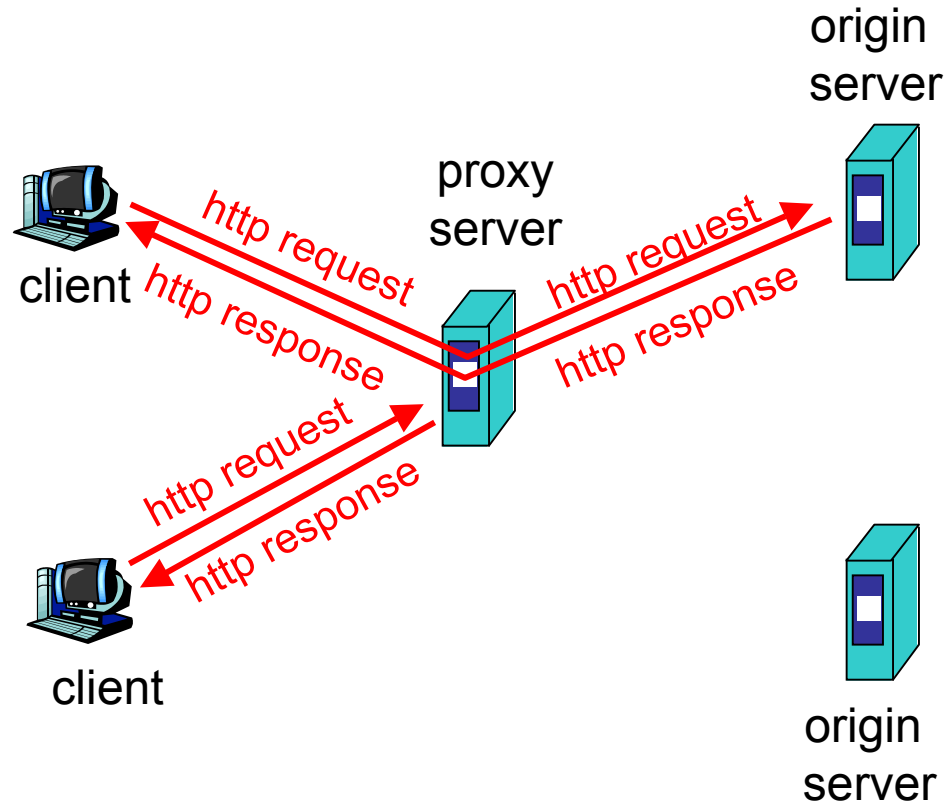



# Why Web Caching?

- Assumption: cache is “close” to client (e.g., in same network)
- Smaller response time: cache “closer” to client
- Decrease traffic to distant servers
- Link out of institutional/local ISP network is often a bottleneck

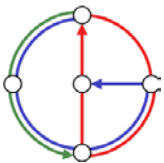
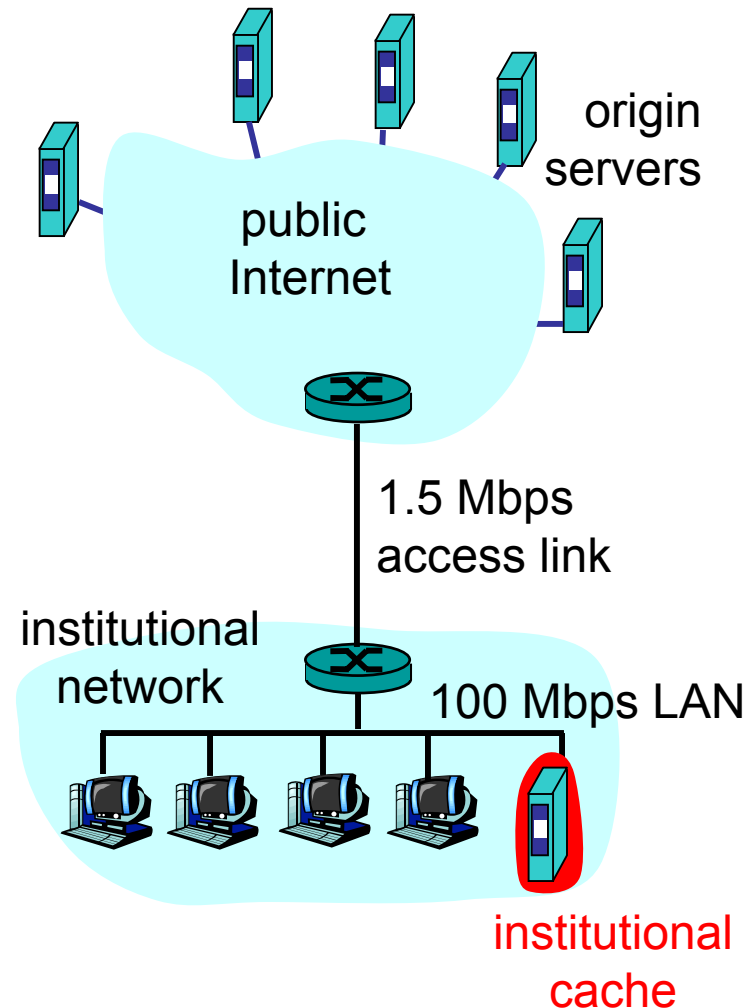

# ftp: The file transfer protocol



- transfer file to/from remote host
- client/server model
  - client: side that initiates transfer (either to/from remote)
  - server: remote host
- ftp: RFC 959
- ftp server: port 21

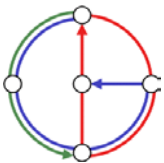
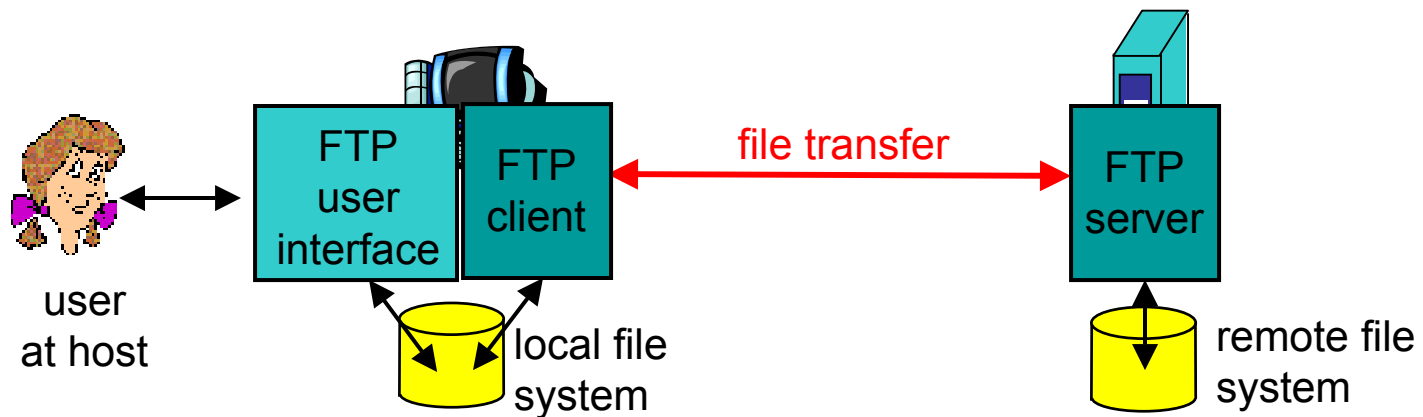

# ftp: separate control and data connections



- ftp client contacts ftp server at port 21, specifying TCP as transport protocol
- two parallel TCP connections opened
  - control: exchange commands, responses between client, server. “out of band control”
  - data: file data to/from server
- ftp server maintains “state”: current directory, earlier authentication

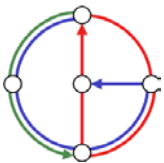
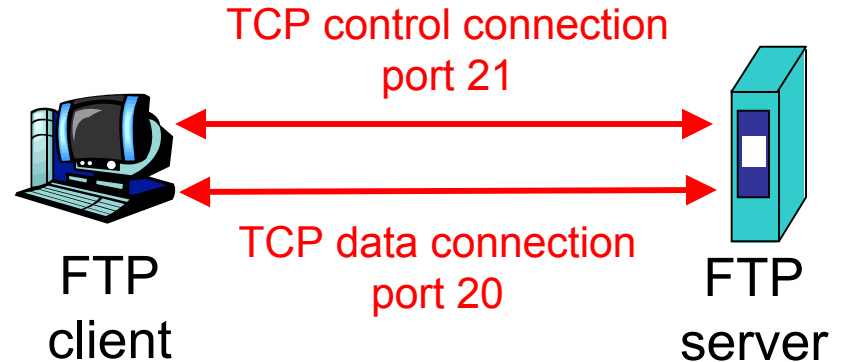

# ftp commands and responses



## Sample commands

- sent as ASCII text over control channel
- **USER *username***
- **PASS *password***
- **LIST** returns list of files in current directory
- **RETR *filename*** retrieves (gets) file
- **STOR *filename*** stores (puts) file onto remote host

## Sample return codes

- status code and phrase (as in http)
- **331 Username OK, password required**
- **125 data connection already open; transfer starting**
- **425 Can't open data connection**
- **452 Error writing file**

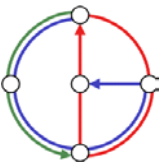

# Electronic Mail

## Three major components

- user agents
- mail servers
- simple mail transfer protocol: smtp

## User Agent

- a.k.a. “mail reader”
- composing, editing, reading mail messages
- Examples: Outlook, Netscape Messenger, elm, Eudora
- outgoing, incoming messages stored on server

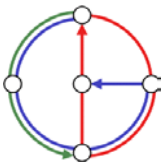
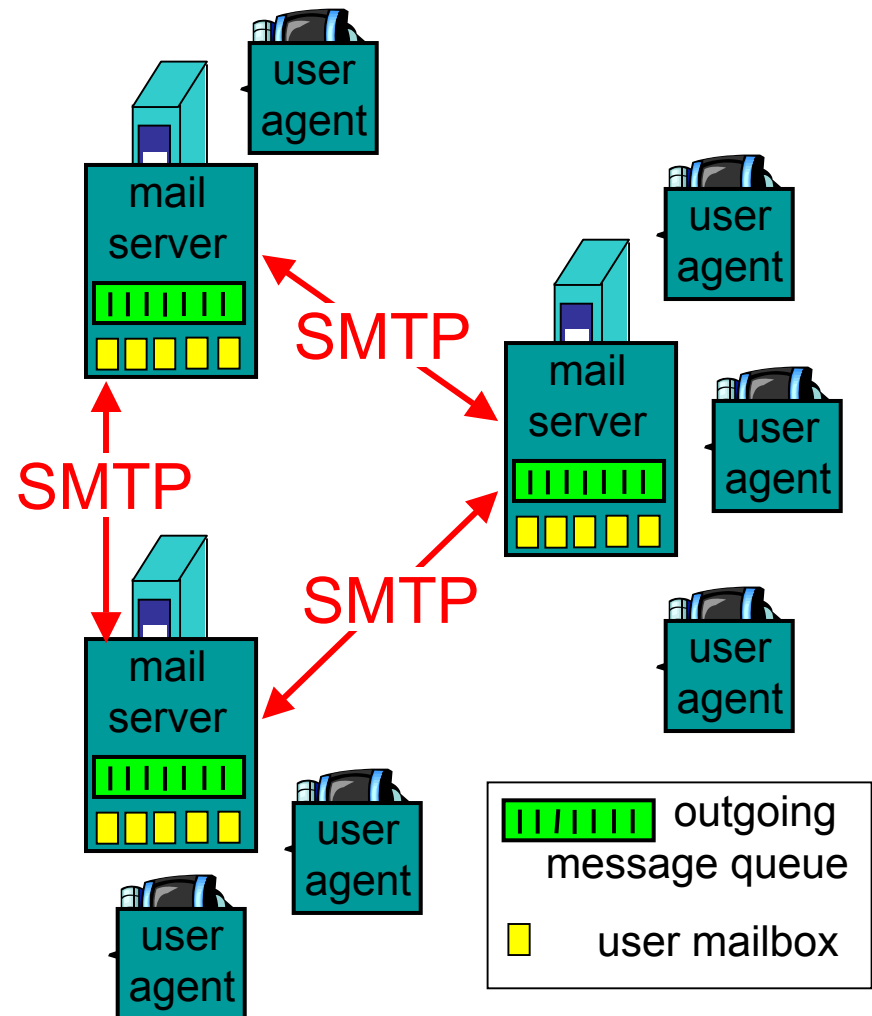

# Electronic Mail: mail servers

- mailbox contains incoming messages (yet to be read) for user
- message queue of outgoing (to be sent) mail messages
- smtp protocol between mail servers to send email messages
  - “client”: sending mail server
  - “server”: receiving mail server
- Why not sending directly?

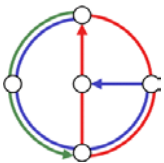
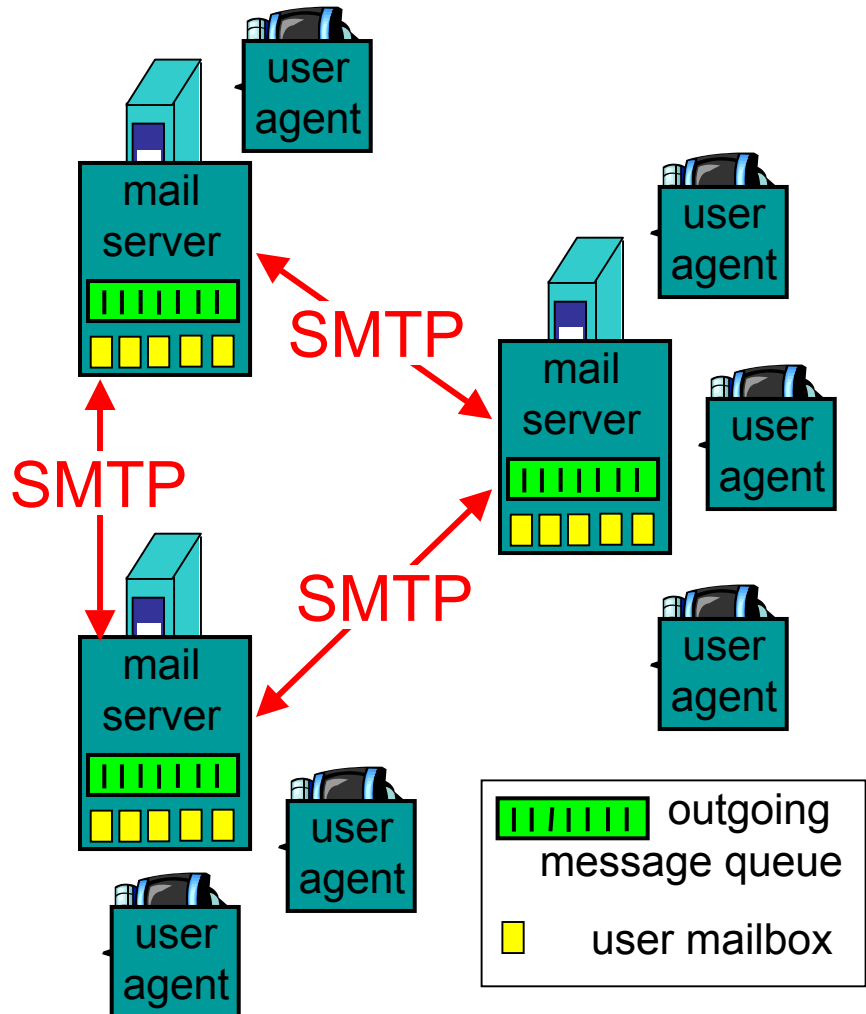

# Electronic Mail: SMTP



- uses TCP to reliably transfer email message from client to server, on port 25
- direct transfer: sending server to receiving server
- three phases of transfer
  - handshake (greeting)
  - transfer of messages
  - closure
- command/response interaction
  - commands: ASCII text
  - response: status code and phrase
- SMTP: RFC 821

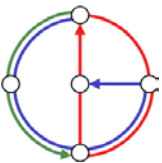

# Sample smtp interaction



```
S: 220 hamburger.edu
C: HELO crepes.fr
S: 250 Hello crepes.fr, pleased to meet you
C: MAIL FROM: <alice@crepes.fr>
S: 250 alice@crepes.fr... Sender ok
C: RCPT TO: <bob@hamburger.edu>
S: 250 bob@hamburger.edu ... Recipient ok
C: DATA
S: 354 Enter mail, end with "." on a line by itself
C: Do you like ketchup?
C:   How about pickles?
C: .
S: 250 Message accepted for delivery
C: QUIT
S: 221 hamburger.edu closing connection
```

You can be your own smtp client: telnet to a mail server you know  
(`telnet mail.inf.ethz.ch 25`) and play with the protocol...

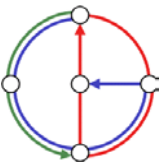



## smtp: more details



- smtp uses persistent connections
- smtp requires message (header & body) to be in 7-bit ASCII
- certain character strings not permitted in msg (e.g., `CRLF.CRLF`, which is used to determine the end of a message by the server).
- Thus msg has to be encoded (usually into either base-64 or quoted printable)

### Comparison with http

- http: pull
- email: push
- both have ASCII command/response interaction and status codes
- http: each object encapsulated in its own response msg (1.0), or by use of content-length field (1.1)
- smtp: multiple objects sent in multipart msg (as we will see on the next slides)

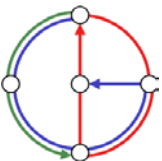

# Mail message format



- smtp: protocol for exchanging email msgs
- RFC 822: standard for text message format:
- header lines, e.g.,
  - To:
  - From:
  - Subject:
  - Caution: these are not smtp commands! They are like the header of a letter; whereas smtp commands are like the address on the envelope
- body
  - the “message”
  - ASCII characters only

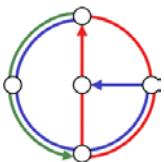
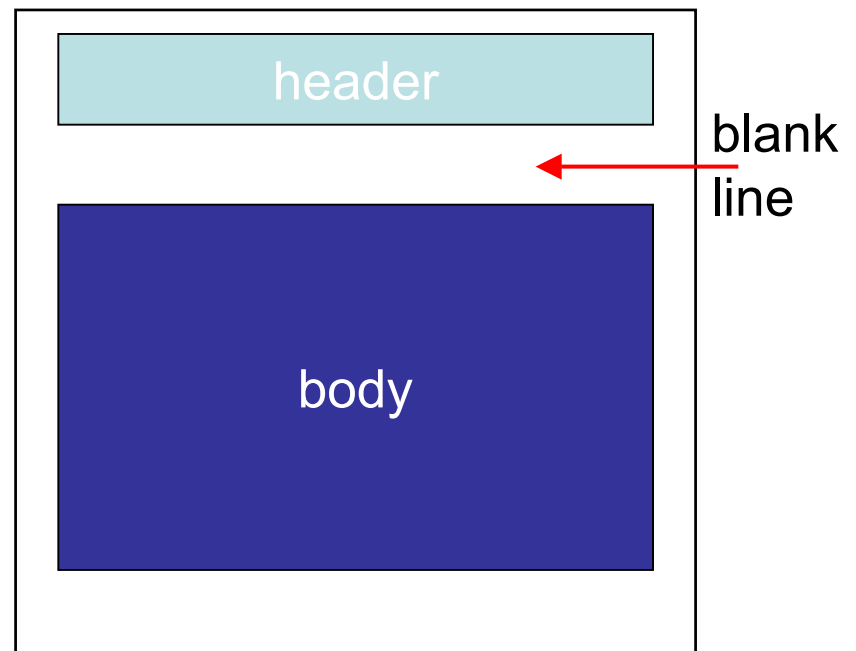

# Message format: multimedia extensions



- MIME: multimedia mail extension, RFC 2045, 2056
- additional lines in message header declare MIME content type

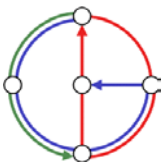
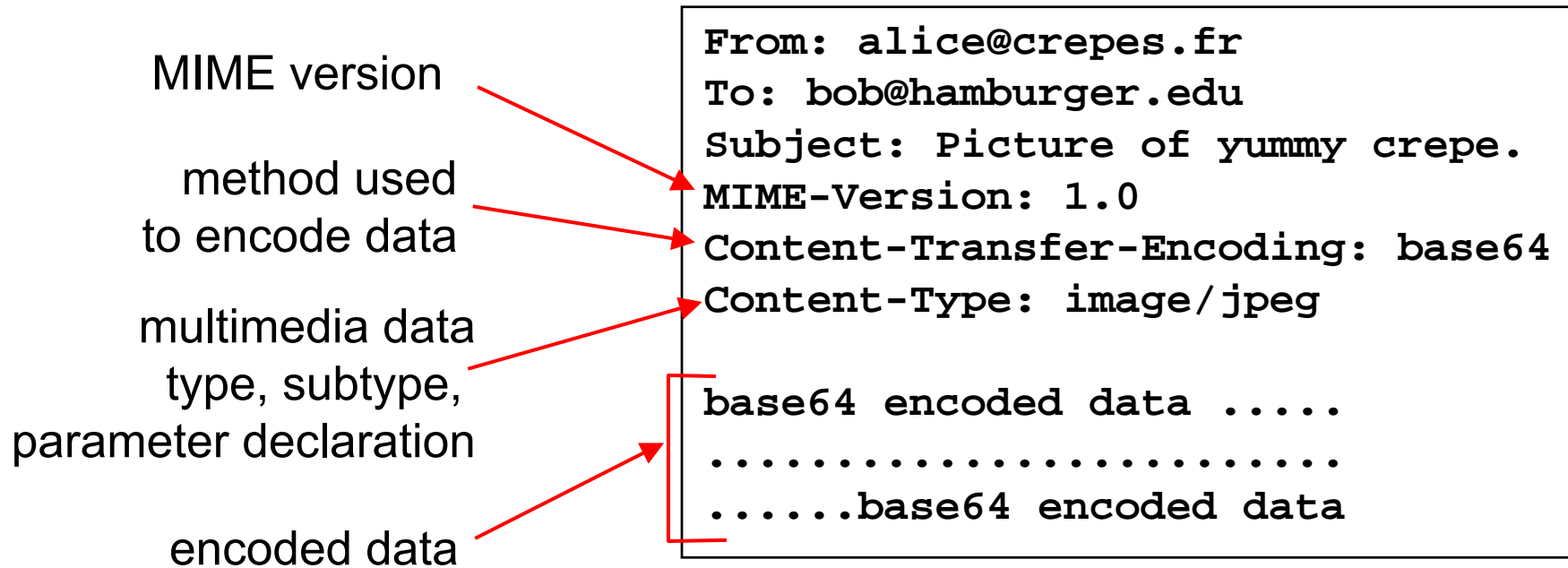

# MIME types



**Content-Type: type/subtype; parameters**

## Text

- example subtypes: **plain**, **enriched**, **html**

## Video

- example subtypes: **mpeg**, **quicktime**

## Image

- example subtypes: **jpeg**, **gif**

## Application

- other data that must be processed by reader before “viewable”
- example subtypes: **msword**, **octet-stream**

## Audio

- example subtypes: **basic** (8-bit mu-law encoded), **32kadpcm** (32 kbps coding)

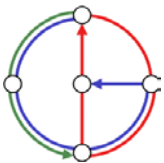

# MIME Multipart Type



```
From: alice@crepes.fr
To: bob@hamburger.edu
Subject: Picture of yummy crepe.
MIME-Version: 1.0
Content-Type: multipart/mixed; boundary=98766789
```

```
--98766789
Content-Transfer-Encoding: quoted-printable
Content-Type: text/plain
```

```
Dear Bob,
Please find a picture of a crepe.
```

```
--98766789
Content-Transfer-Encoding: base64
Content-Type: image/jpeg
```

```
base64 encoded data .....
.....
.....base64 encoded data
--98766789--
```

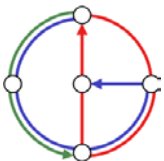

# Mail access protocols



- SMTP: delivery/storage to receiver's server
- Mail access protocol: retrieval from server
  - POP: Post Office Protocol [RFC 1939]
    - authorization (agent <-->server) and download
  - IMAP: Internet Mail Access Protocol [RFC 2060]
    - more features (more complex)
    - manipulation of stored messages on server
  - HTTP: Hotmail, Yahoo! Mail, etc.

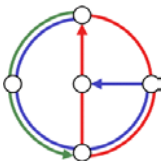
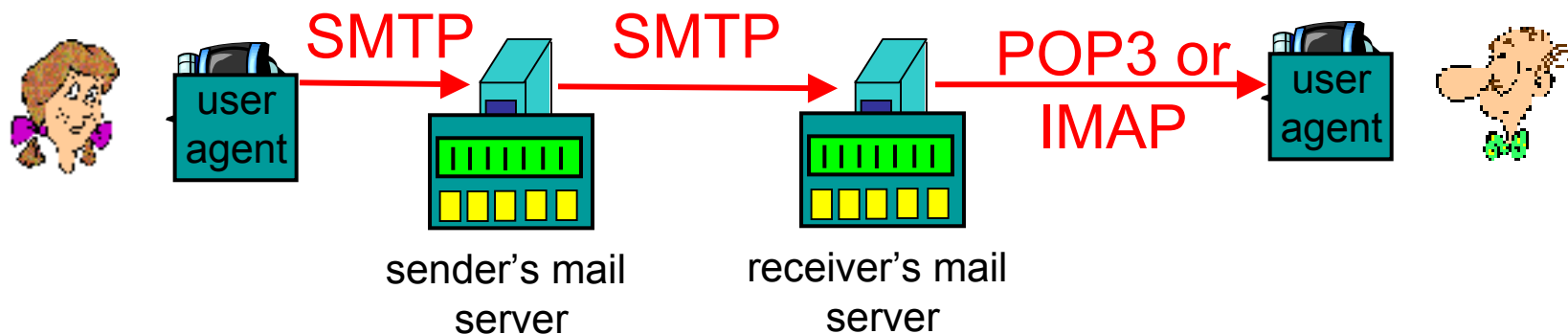

# POP3 protocol



## Authorization phase

- client commands:
  - user: declare username
  - pass: password
- server responses
  - +OK
  - -ERR

## Transaction phase

- client commands
  - list: list message numbers
  - retr: retrieve message by number
  - dele: delete
  - quit

```
S: +OK POP3 server ready
C: user alice
S: +OK
C: pass hungry
S: +OK user successfully logged on
```

```
C: list
S: 1 498
S: 2 912
S: .
C: retr 1
S: <message 1 contents>
S: .
C: dele 1
C: retr 2
S: <message 1 contents>
S: .
C: dele 2
C: quit
S: +OK POP3 server signing off
```

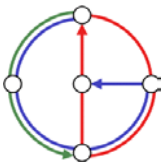

# DNS: Domain Name System



## People have many identifiers

- passport number, AHV number, student number, name, etc.

## Internet hosts, routers

- IP address (129.132.130.152); used for addressing datagrams
- Name (photek.ethz.ch); used by humans
- We need a map from names to IP addresses (and vice versa?)

## Domain Name System

- *distributed database* implemented in hierarchy of many *name servers*
- *application-layer protocol* host, routers, name servers to communicate to *resolve* names (name/address translation)
  - note: is a core Internet function, but only implemented as application-layer protocol
  - complexity at network's "edge"

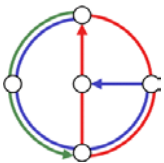



# DNS name servers



## Why not centralize DNS?

- single point of failure
- traffic volume
- distant centralized database
- maintenance

...it does not *scale!*

- no server has all name-to-IP address mappings

## local name servers

- each ISP, company has *local (default) name server*
- host DNS query first goes to local name server

## authoritative name server

- for a host: stores that host's IP address, name
- can perform name/address translation for that host's name

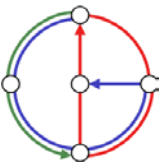

# DNS: Root name servers



- contacted by local name server that can not resolve name
- root name server
  - contacts authoritative name server if name mapping not known
  - gets mapping
  - returns mapping to local name server
  - currently 13 root name servers worldwide

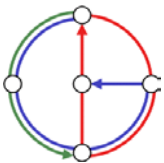
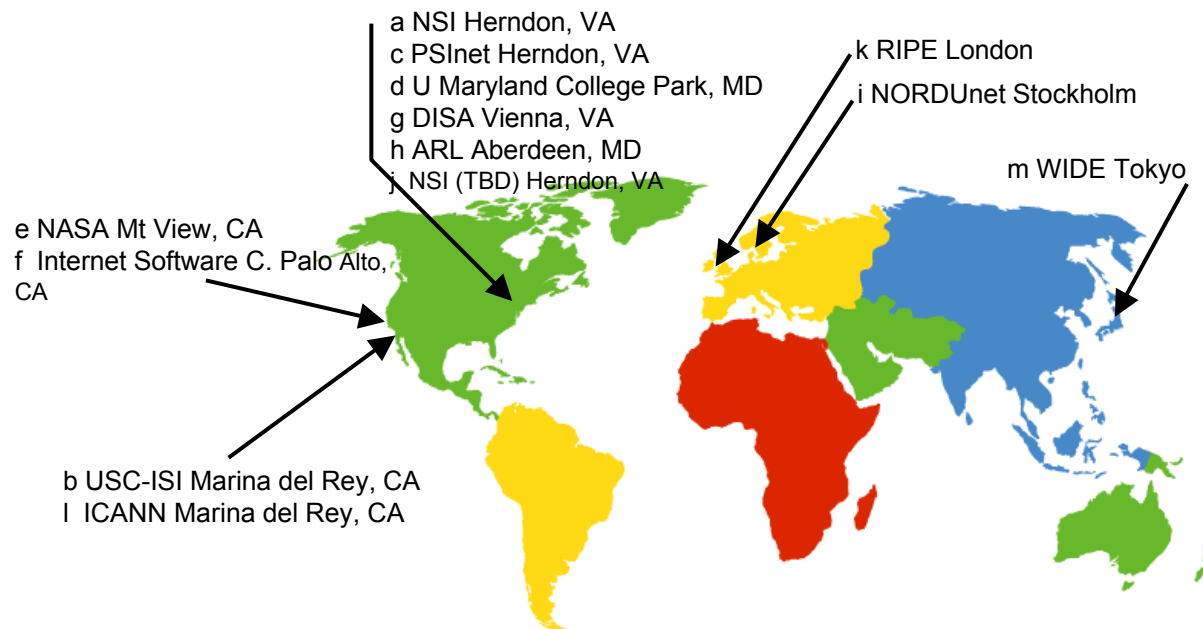

# Simple DNS example



- host photek.ethz.ch wants IP address of gaia.cs.umass.edu

1. contact local DNS server, dns.ethz.ch
2. dns.ethz.ch contacts root name server, if necessary
3. root name server contacts authoritative name server, dns.umass.edu, if necessary

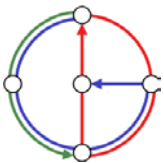
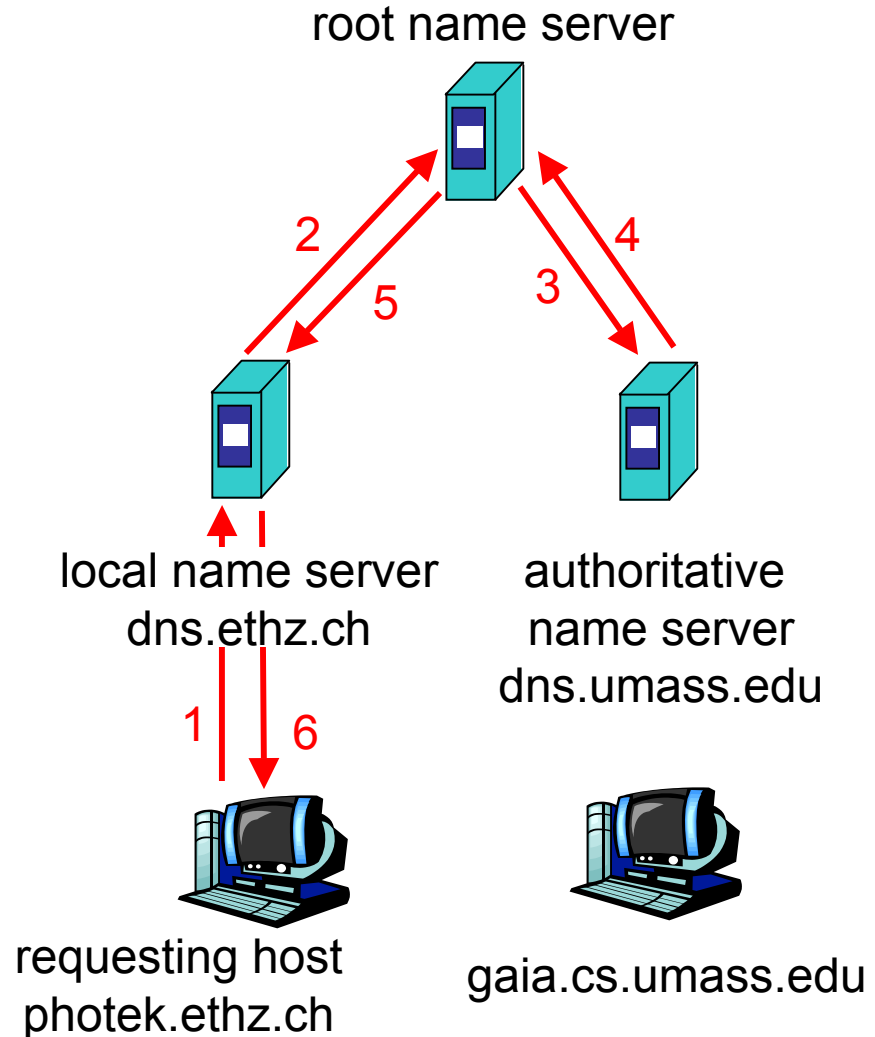

# DNS extended example



Root name server:

- may not know authoritative name server
- may know *intermediate name server*: who to contact to find authoritative name server

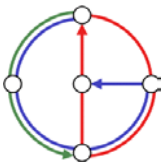
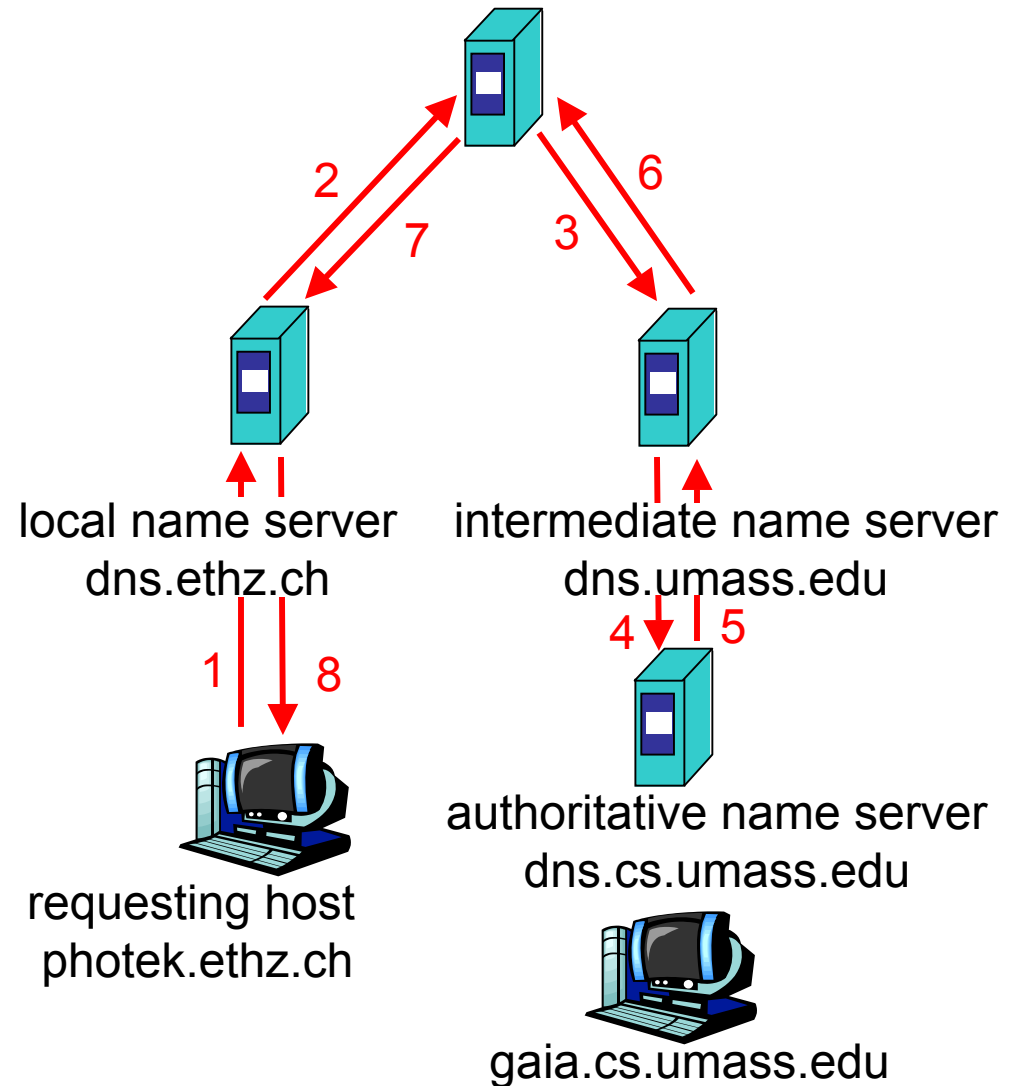

# DNS Iterated queries



## Recursive query

- puts burden of name resolution on contacted name server
- heavy load?

## Iterated query

- contacted server replies with name of server to contact
- “I don’t know this name, but ask this server”

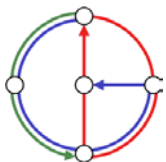
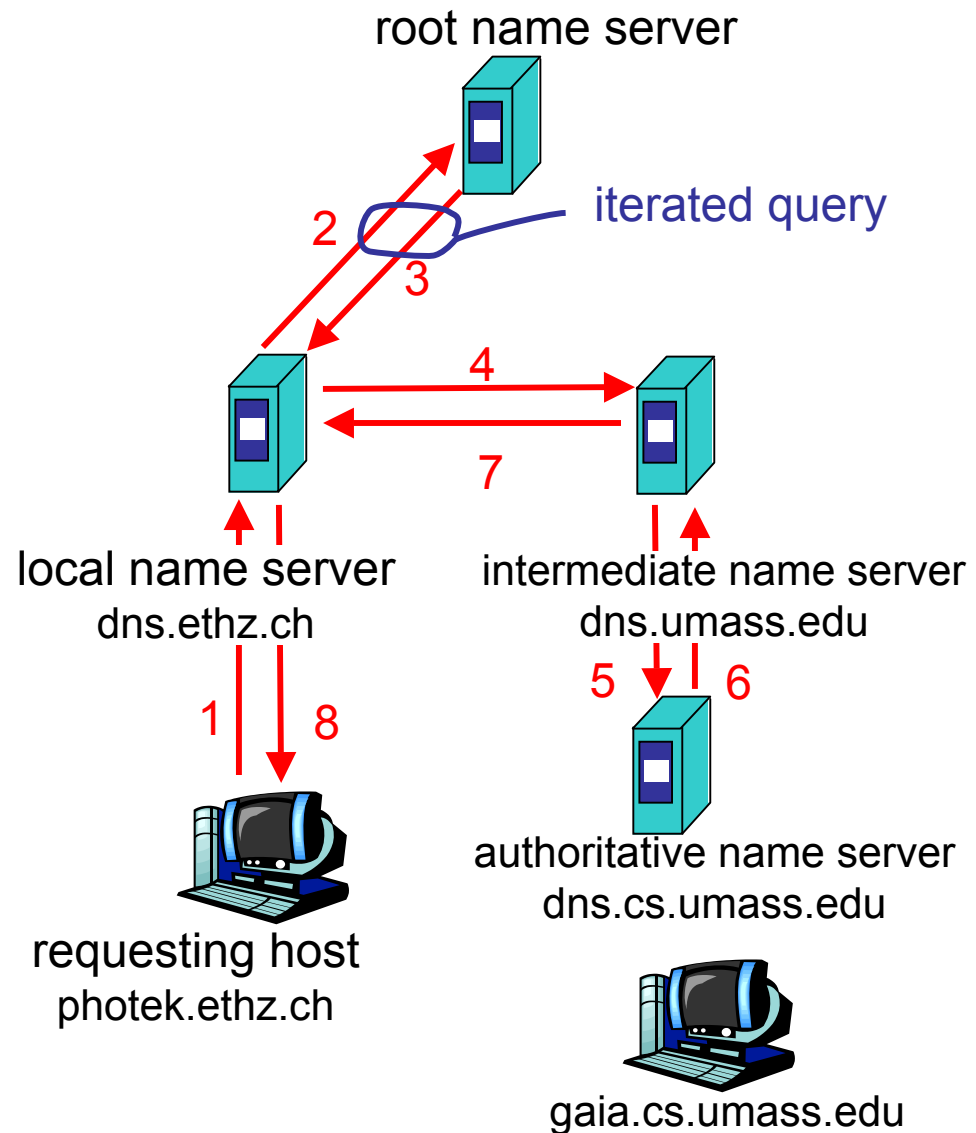

# DNS: Caching and updating records



- once (any) name server learns mapping, it *cache*s mapping
  - cache entries timeout (disappear) after some time
- update/notify mechanisms under design by IETF
  - RFC 2136
  - <http://www.ietf.org/html.charters/dnsind-charter.html>

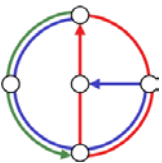

# DNS resource records



DNS: distributed database storing resource records (RR)

**RR format: (name, ttl, class, type, value)**

- Type=A
  - **name** is hostname
  - **value** is IP address
- Type=NS
  - **name** is domain (e.g. foo.com)
  - **value** is IP address of authoritative name server for this domain
- Type=CNAME
  - **name** is alias name for some “canonical” (the real) name  
`www.ibm.com` is really  
`servereast.backup2.ibm.com`
  - **value** is canonical name
- Type=MX
  - **value** is name of mail server associated with **name**

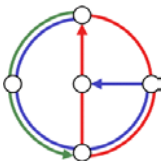

# Example of DNS lookup



```
host -v dcg.ethz.ch
Trying "dcg.ethz.ch"
;; ->>HEADER<<- opcode: QUERY, status: NOERROR, id: 27554
;; flags: qr aa rd ra; QUERY: 1, ANSWER: 1, AUTHORITY: 3,
   ADDITIONAL: 3

;; QUESTION SECTION:
;dcg.ethz.ch.                IN      ANY

;; ANSWER SECTION:
dcg.ethz.ch.                86400   IN      CNAME   dcg.inf.ethz.ch.

;; AUTHORITY SECTION:
ethz.ch.                    3600000 IN      NS      dns1.ethz.ch.
ethz.ch.                    3600000 IN      NS      dns2.ethz.ch.
ethz.ch.                    3600000 IN      NS      dns3.ethz.ch.

;; ADDITIONAL SECTION:
dns1.ethz.ch.               86400   IN      A       129.132.98.12
dns2.ethz.ch.               86400   IN      A       129.132.250.220
dns3.ethz.ch.               86400   IN      A       129.132.250.2
```

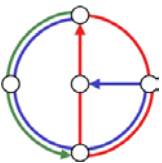



# DNS protocol, messages



## DNS protocol

- *query* and *reply* messages, both with same *message format*

## msg header

- identification: 16 bit number for query, reply to query uses same number
- flags:
  - query or reply
  - recursion desired
  - recursion available
  - reply is authoritative

identification	flags
number of questions	number of answer RRs
number of authority RRs	number of additional RRs
questions (variable number of questions)	
answers (variable number of resource records)	
authority (variable number of resource records)	
additional information (variable number of resource records)	

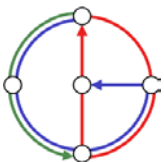

# DNS protocol, messages

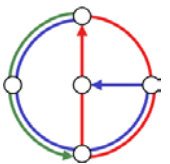
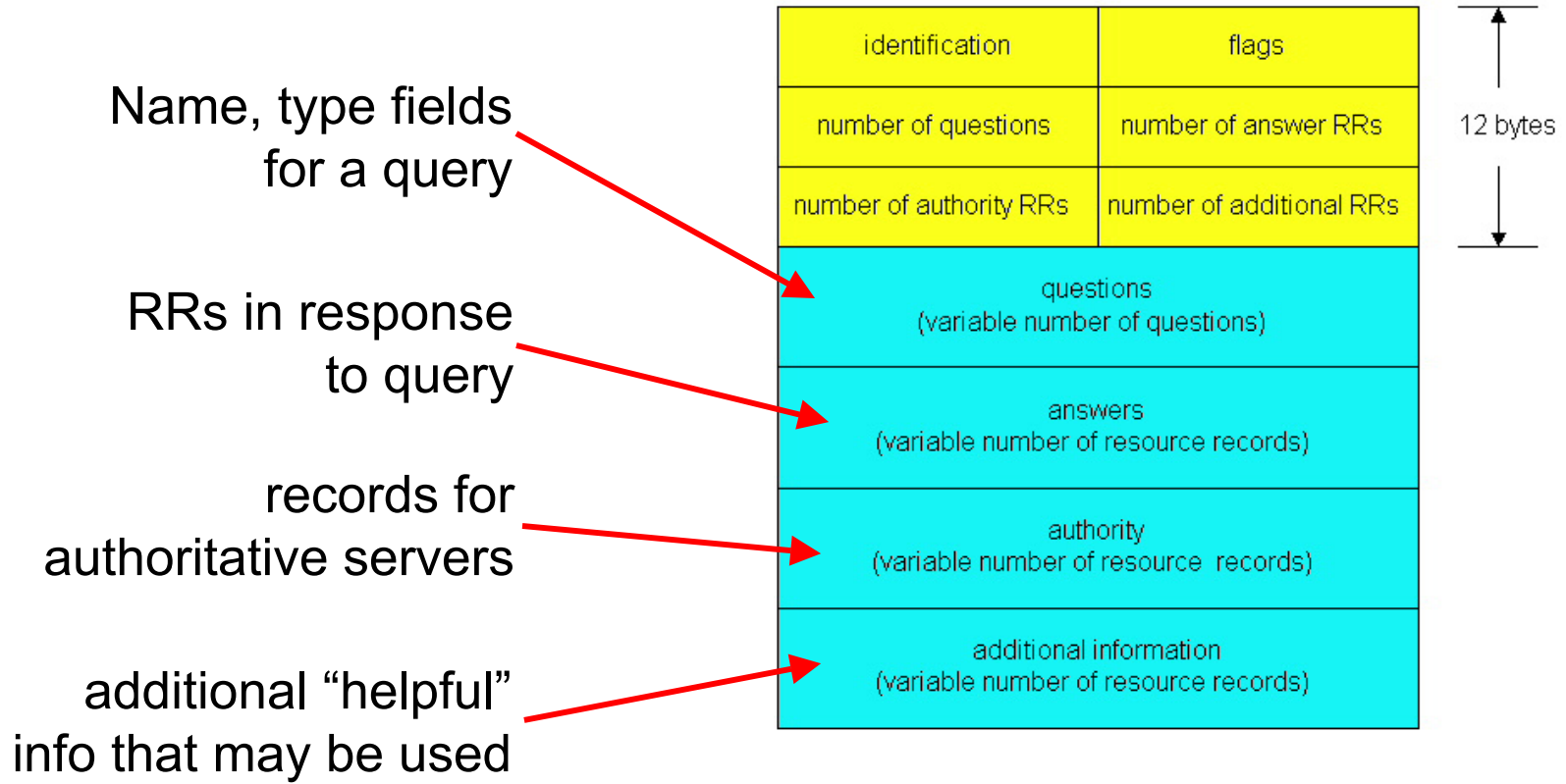

# Socket programming



## Goal

- Learn building client/server applications that communicate using sockets, the standard application programming interface

## Socket API

- introduced in BSD4.1 UNIX, 1981
- explicitly created, used, released by applications
- client/server paradigm
- two types of transport service via socket API
  - unreliable datagram
  - reliable, byte stream-oriented

## socket

*a host-local, application-created/owned, OS-controlled interface (a “door”) into which application process can both send and receive messages to/from another (remote or local) application process*

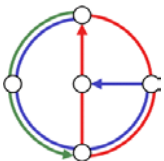

# Socket programming with TCP



## Socket

- a door between application process and end-end-transport protocol (UDP or TCP)

## TCP service

- reliable transfer of *bytes* from one process to another

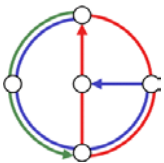
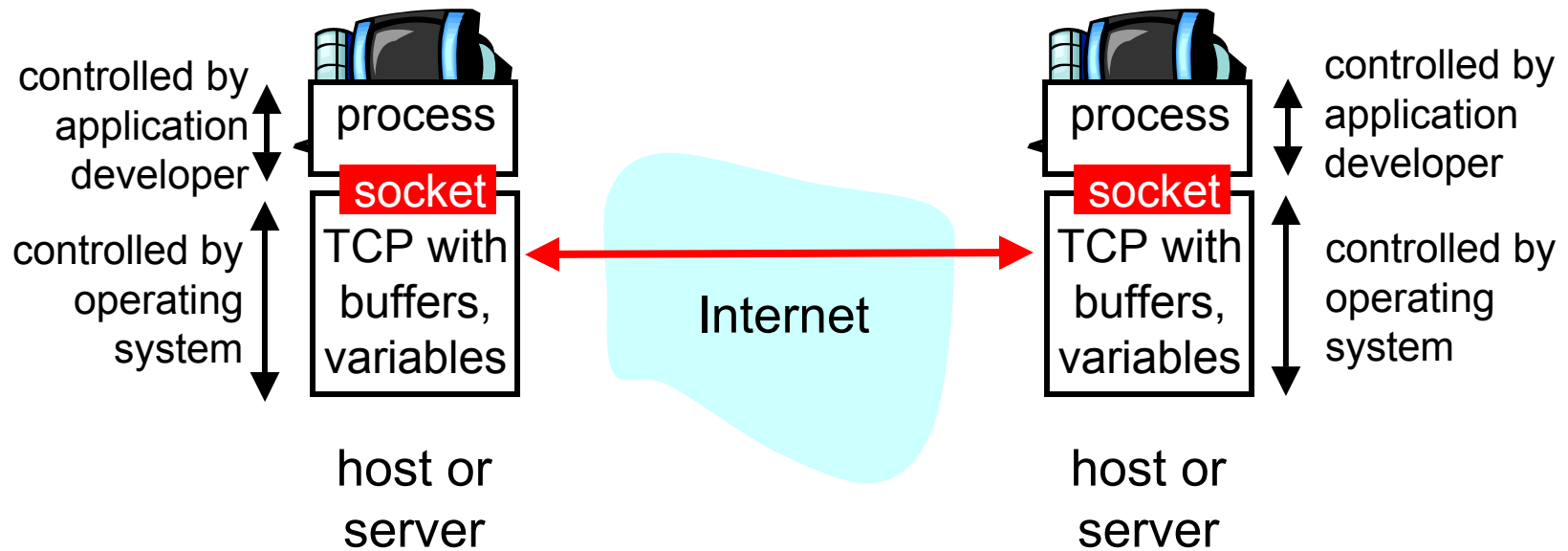

# Socket programming with TCP



## Client must contact server

- server process must first be running already
- server must have created socket (“door”) that welcomes client’s contact

## Client contacts server by

- creating client-local TCP socket
- specifying IP address and port number of server process

- When client creates socket: client TCP establishes connection to server TCP
- When contacted by client, server TCP creates new socket for server process to communicate with client
  - allows server to talk with multiple clients

## application viewpoint

*TCP provides reliable, in-order transfer of bytes (“pipe”) between client and server*

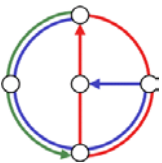

# Socket programming with TCP (Java)



## Example client-server application

- client reads line from standard input (`inFromUser` stream), sends to server via socket (`outToServer` stream)
- server reads line from socket
- server converts line to uppercase, sends back to client
- client reads and prints modified line from socket (`inFromServer` stream)

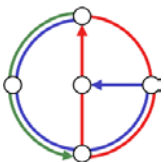
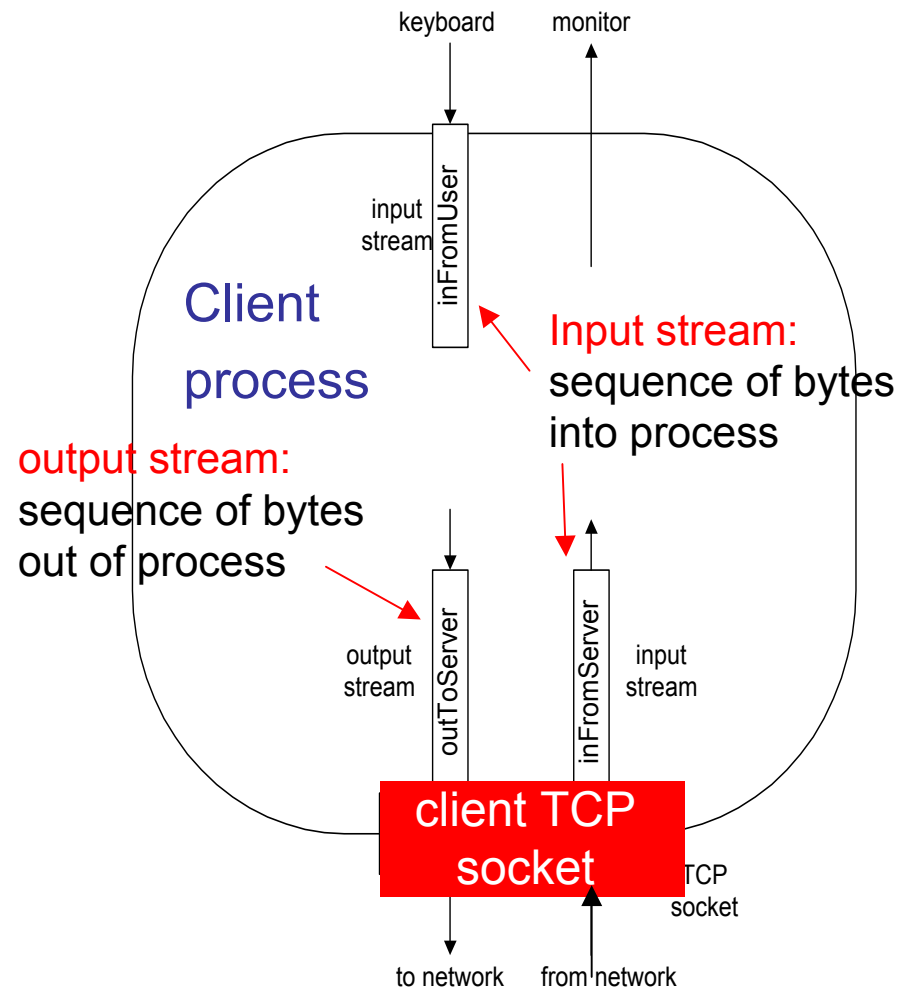

# Client/server socket interaction with TCP (Java)



Server (running on **hostid**)

Client

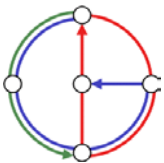
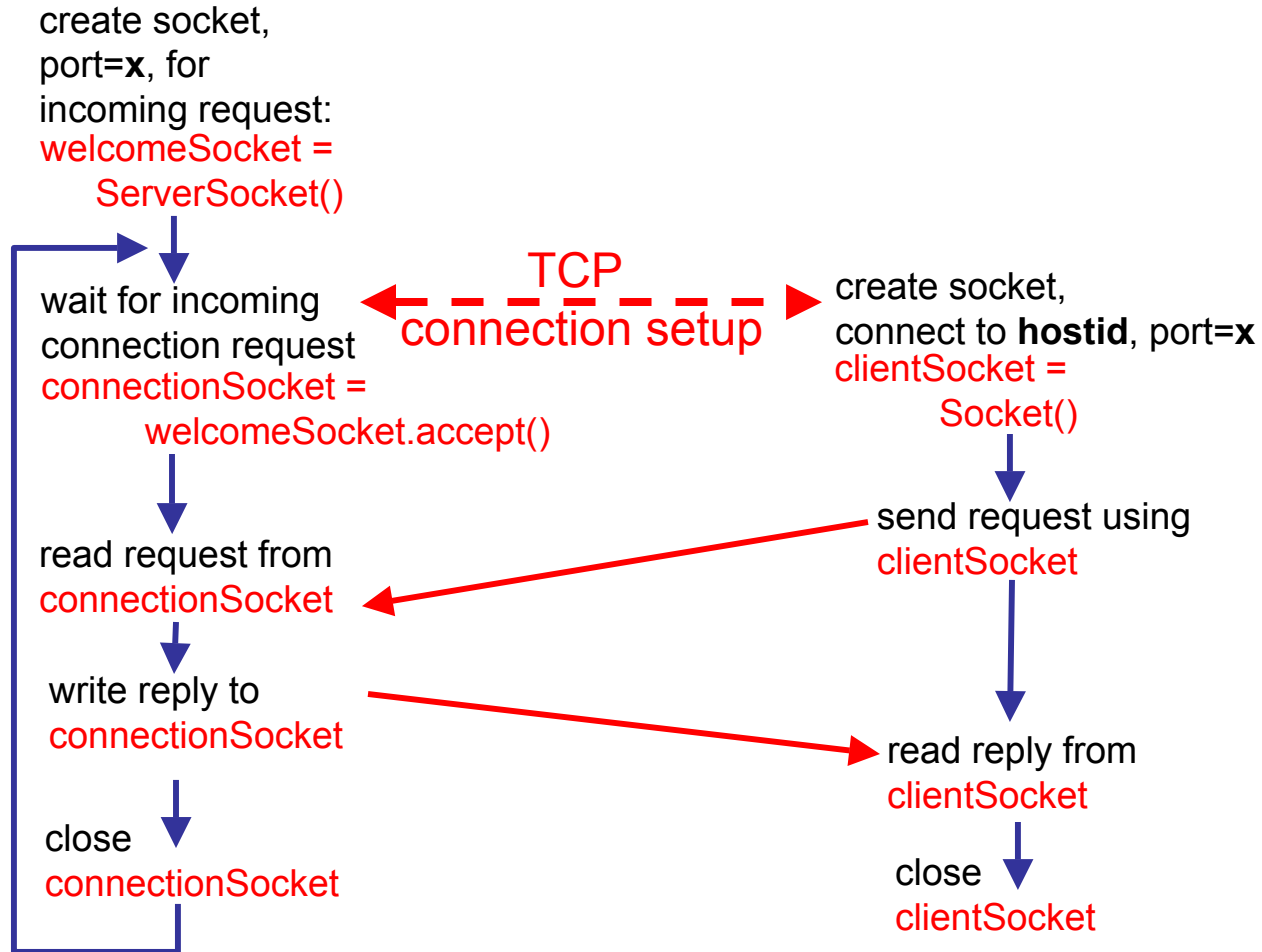

# Example: Java client (TCP)



```
import java.io.*;  
import java.net.*;
```

```
class TCPClient {  
    public static void main(String argv[]) throws Exception  
    {  
        String sentence;  
        String modifiedSentence;
```

Create  
input stream



```
        BufferedReader inFromUser =  
            new BufferedReader(new InputStreamReader(System.in));
```

Create  
client socket,  
connect to server



```
        Socket clientSocket = new Socket("hostname", 6789);
```

Create  
output stream  
attached to socket



```
        DataOutputStream outToServer =  
            new DataOutputStream(clientSocket.getOutputStream());
```

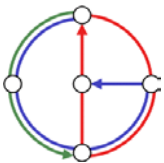



# Example: Java client (TCP), continued



Create  
input stream  
attached to socket

```
BufferedReader inFromServer =  
    new BufferedReader(new  
        InputStreamReader(clientSocket.getInputStream()));
```

Send line  
to server

```
sentence = inFromUser.readLine();  
  
outToServer.writeBytes(sentence + '\n');
```

Read line  
from server

```
modifiedSentence = inFromServer.readLine();  
  
System.out.println("FROM SERVER: " + modifiedSentence);  
  
clientSocket.close();
```

```
}  
}
```

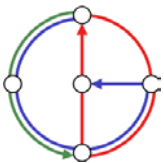

# Example: Java server (TCP)



```
import java.io.*;  
import java.net.*;
```

```
class TCPServer {
```

```
    public static void main(String argv[]) throws Exception  
    {
```

```
        String clientSentence;  
        String capitalizedSentence;
```

Create  
welcoming socket  
at port 6789



```
        ServerSocket welcomeSocket = new ServerSocket(6789);
```

Wait on welcoming  
socket for contact  
by client



```
        while(true) {
```

```
            Socket connectionSocket = welcomeSocket.accept();
```

Create input  
stream, attached  
to socket



```
            BufferedReader inFromClient =  
                new BufferedReader(new  
                    InputStreamReader(connectionSocket.getInputStream()));
```

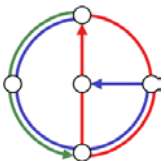

# Example: Java server (TCP), continued



Create output stream, attached to socket

```
DataOutputStream outToClient =  
    new DataOutputStream(connectionSocket.getOutputStream());
```

Read in line from socket

```
clientSentence = inFromClient.readLine();
```

```
capitalizedSentence = clientSentence.toUpperCase() + '\n';
```

Write out line to socket

```
outToClient.writeBytes(capitalizedSentence);
```

```
}  
}  
}
```

End of while loop, loop back and wait for another client connection

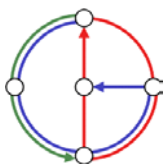

# Problem: One client can block other clients



Problem can be solved with threads:

```
ServerSocket welcomeSocket = new ServerSocket(6789);
while(true) {
    Socket connectionSocket = welcomeSocket.accept();
    ServerThread s = new ServerThread(connectionSocket);
    s.start();
}
```

```
public class ServerThread extends Thread {
    /* Handles connection socket */
    /* "More or less" code of old server loop */
}
```

Alternative solution: Client opens socket after reading input line!

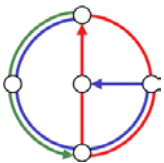

# Socket programming with UDP



Remember: UDP: no “connection” between client and server

- no handshaking
- sender explicitly attaches IP address and port of destination
- server must extract IP address, port of sender from received datagram
  
- UDP: transmitted data may be received out of order, or lost

application viewpoint

*UDP provides unreliable transfer of groups of bytes (“datagrams”) between client and server*

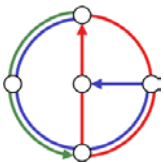

# Client/server socket interaction: UDP (Java)



## Server (running on **hostid**)

## Client

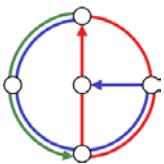
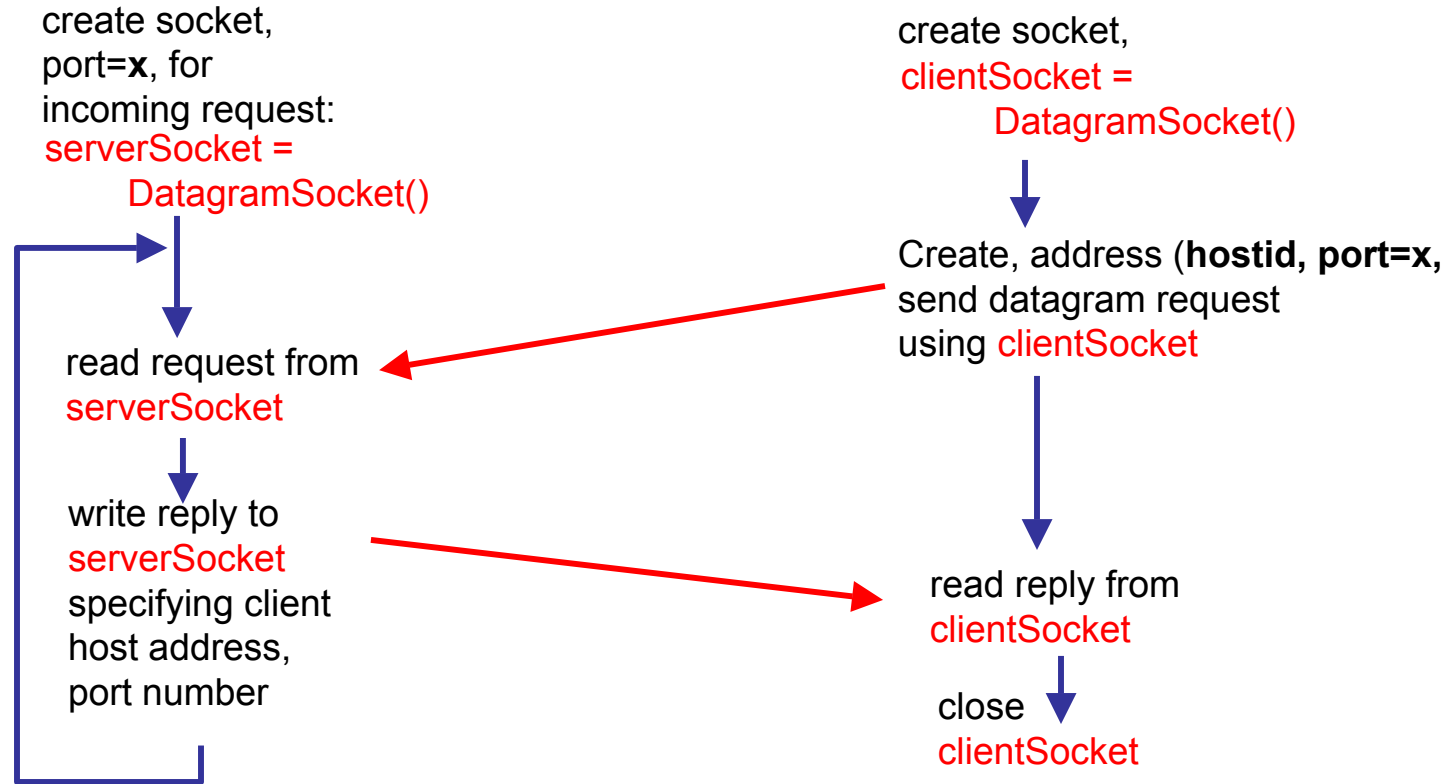

# Example: Java client (UDP)

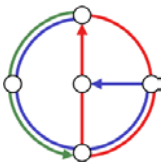
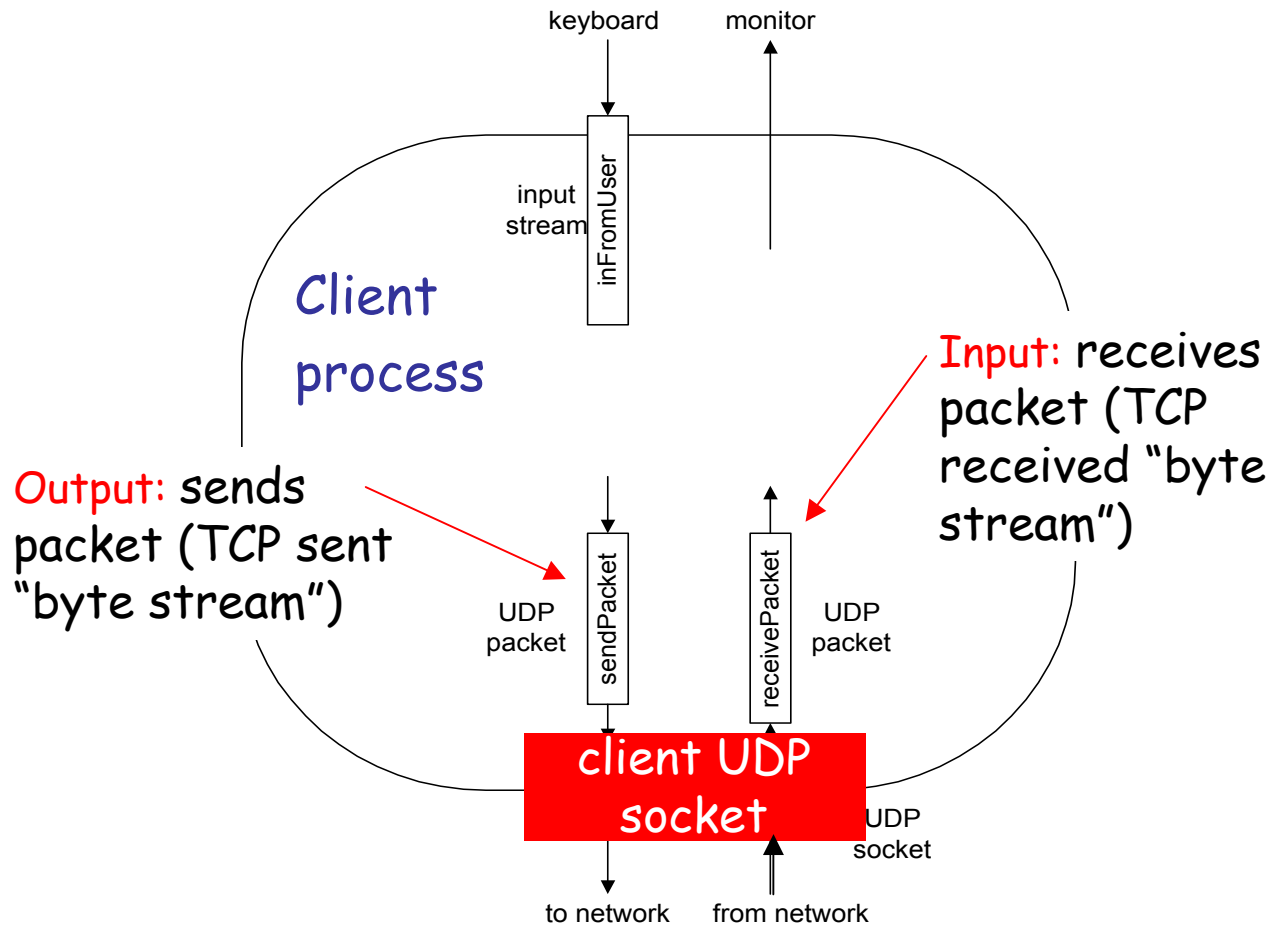

# Example: Java client (UDP)



```
import java.io.*;
import java.net.*;
```

```
class UDPClient {
    public static void main(String args[]) throws Exception
    {
```

Create  
input stream



```
    BufferedReader inFromUser =
```

```
        new BufferedReader(new InputStreamReader(System.in));
```

Create  
client socket



```
    DatagramSocket clientSocket = new DatagramSocket();
```

Translate  
hostname to IP  
Address using DNS



```
    InetAddress IPAddress = InetAddress.getByName("hostname");
```

```
    byte[] sendData = new byte[1024];
```

```
    byte[] receiveData = new byte[1024];
```

```
    String sentence = inFromUser.readLine();
```

```
    sendData = sentence.getBytes();
```

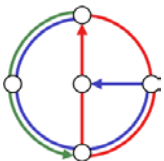



# Example: Java client (UDP), continued



```

Create datagram with
  data-to-send,
  length, IP addr, port } DatagramPacket sendPacket =
                          } new DatagramPacket(sendData, sendData.length, IPAddress, 9876);

Send datagram
  to server } clientSocket.send(sendPacket);

Read datagram
  from server } DatagramPacket receivePacket =
                } new DatagramPacket(receiveData, receiveData.length);
                } clientSocket.receive(receivePacket);

String modifiedSentence =
  new String(receivePacket.getData());

System.out.println("FROM SERVER:" + modifiedSentence);
clientSocket.close();
}
}

```

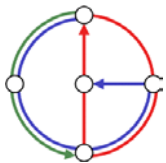

# Example: Java server (UDP)



```
import java.io.*;
import java.net.*;
```

```
class UDPServer {
    public static void main(String args[]) throws Exception
    {
```

Create  
datagram socket  
at port 9876



```
DatagramSocket serverSocket = new DatagramSocket(9876);
```

```
byte[] receiveData = new byte[1024];
byte[] sendData = new byte[1024];
```

```
while(true)
{
```

Create space for  
received datagram



```
DatagramPacket receivePacket =
    new DatagramPacket(receiveData, receiveData.length);
```

Receive  
datagram



```
serverSocket.receive(receivePacket);
```

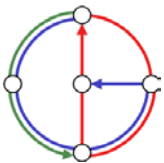

# Example: Java server (UDP), continued



```
String sentence = new String(receivePacket.getData());
```

Get IP addr  
port #, of  
sender

```
InetAddress IPAddress = receivePacket.getAddress();
```

```
int port = receivePacket.getPort();
```

```
String capitalizedSentence = sentence.toUpperCase();
```

```
sendData = capitalizedSentence.getBytes();
```

Create datagram  
to send to client

```
DatagramPacket sendPacket =  
new DatagramPacket(sendData, sendData.length, IPAddress,  
port);
```

Write out  
datagram  
to socket

```
serverSocket.send(sendPacket);
```

```
}  
}  
}
```

End of while loop,  
loop back and wait for  
another datagram

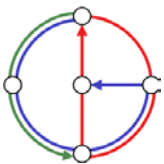

# Network System in Active Oberon / Bluebottle



- AosNet: Defines a generic network device.
- AosIP: Offers IP
- AosTCP
  - Contains a Connection-oriented class that keeps track of the connection status
  - Offers a Receive and a Send Method
- AosUDP: Offers datagram services
- AosDNS
  - Implements a DNS cache and offers host lookup functionality
- AosTCPServices
  - Offers a simple abstraction to write TCP services

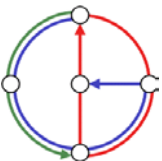

# Establishing a Client to Server Connection



*Client wants to connect to „huga.ethz.ch“ on port 80*

- It needs to find the IP address with a DNS-Lookup

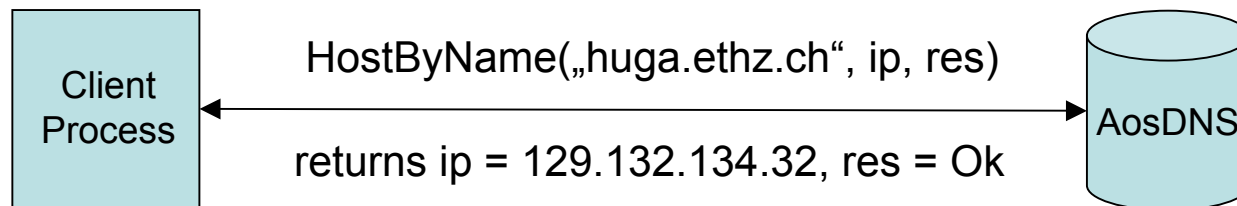

## 2. Open the Connection (to 129.132.134.32:80)

1. NEW(connection);
2. connection.Open(AosIP.NilPort, ip, 80, res);  
AosIP.NilPort tells the system to automatically select the outgoing port.

### AosConnection

```
Open(localPort, ip,  
foreignPort, res);  
Send(...)  
Receive(...)  
Close
```

## 3. If res = Ok then use the connection

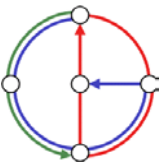

# Open a Server on Port 80 using AosTCPServices



```
AosTCPServices.OpenService(service, 80, generator);
```

This opens port 80 and waits for clients. For each arriving client, **ClientGenerator** is called to instantiate a Handler for this connection.

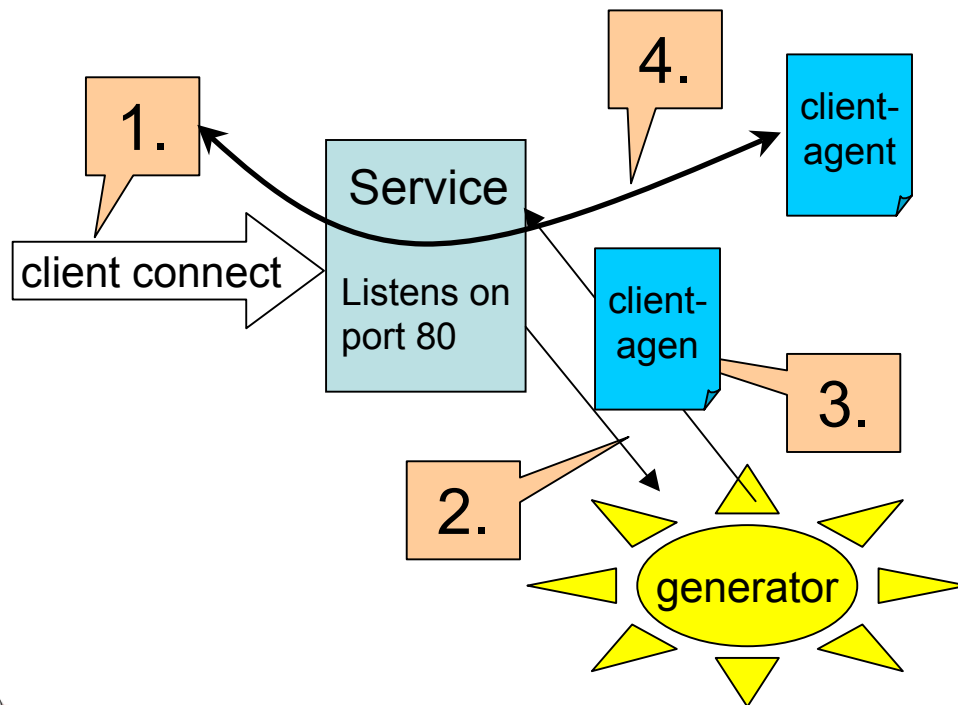

1. Client Request
2. Service calls Generator
3. Generator returns client-agent object
4. Service passes the connection to the client-agent.

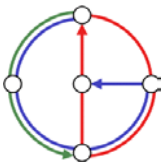

## Open a Server on Port 80 using AosTCPServices



Since the client-agent is an active object that runs in its own process, the service is right-away ready to handle new client requests.

The client-agent must be a subclass of `AosTCPServices.Agent`. `AosTCPServices.Agent` provides the connection “client” and implements code to close the connection.

When the connection is no longer needed – determined either by the protocol state or by a connection failure – the client-agent calls the “Terminate” procedure to close the connection correctly.

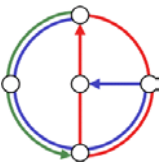

# TCP Client in Active Oberon: RFC865 (Quote of the day)



*The following Active Oberon program opens a TCP client connection to a RFC865 compliant “Quote of the day” server, reads the quote and prints it to the kernel log.*

The program demonstrates these steps:

- Open a reader stream on the „command line“
- Perform a DNS lookup
- Print the IP address to the kernel log
- Open a TCP connection
- Open a reader stream on a TCP connection
- Reading from the connection
- Closing the connection

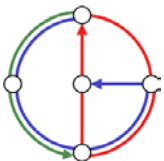



# TCP Client in Active Oberon (1)



```
MODULE RFC865Client; (* Author TF: QOTD Client *)
IMPORT
  AosOut, AosCommands, AosIP, AosDNS, AosTCP, AosIO;
CONST QuotePort = 17;

PROCEDURE GetQuote*(par : PTR) : PTR;
VAR
  s : AosCommands.Parameters;
  sr : AosIO.StringReader;
  connection : AosTCP.Connection;
  serverName : ARRAY 32 OF CHAR;
  line : ARRAY 513 OF CHAR;
  serverIP, res : LONGINT;
  reader : AosIO.Reader;
BEGIN
  s := par(AosCommands.Parameters); (*open reader stream ...*)
  AosIO.OpenStringReader(sr, LEN(s.str^));
  AosIO.SetString(sr, s.str^); (* ... on parameters *)
  AosIO.ReadToken(sr, serverName); (* read server name *)
```

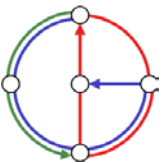

## TCP Client in Active Oberon (2)



```
(* perform a DNS lookup *)
```

```
AosDNS.HostByName(serverName, serverIP, res);
```

```
IF res # 0 THEN (* result not 0 → DNS lookup failed *)
```

```
  AosOut.String("Host not found."); AosOut.Ln;
```

```
  RETURN NIL
```

```
END;
```

```
(* print IP address *)
```

```
AosIP.AdrToStr(serverIP, line);
```

```
AosOut.String("Server found at ");
```

```
AosOut.String(line); AosOut.Ln;
```

```
(* open a connection to the serverIP *)
```

```
NEW(connection);
```

```
connection.Open(AosIP.NilPort, serverIP, QuotePort, res);
```

```
IF res # 0 THEN
```

```
  AosOut.String("Could not connect to host.");
```

```
  AosOut.Ln; RETURN NIL
```

```
END;
```

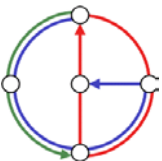

## TCP Client in Active Oberon (3)



```
(* Open a reader stream on the connection receiver *)
AosIO.OpenReader(reader, connection.Receive);
REPEAT
  reader.Ln(line);
  AosOut.String(line); AosOut.Ln
UNTIL reader.res # 0;
(* Close the connection to release the local port *)
connection.Close;
RETURN NIL
END GetQuote;

END RFC865Client.

System.Free RFC865Client ~
System.OpenKernelLog
(* Execute the Aos.Call command to start the program *)
Aos.Call RFC865Client.GetQuote bluebottle.ethz.ch ~
```

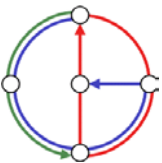

## TCP Server in Active Oberon (1)



*The following Active Oberon program implements an Echo server (RFC 862). The setup of the connection is left to AosTCPServices.*

*AosTCPServices opens the server port and accepts TCP connections to this port. For each connection it starts an Active Object as an agent to handle the requests.*

```
MODULE EchoServer; (*Author pjm; PURPOSE: TCP echo server*)
IMPORT AosModules, AosOut, AosTCP, AosTCPServices, AosIO;
CONST EchoPort = 7; EchoBufSize = 4096;
TYPE
  (* EchoAgent is a subclass of AosTCPServices.Agent *)
  EchoAgent = OBJECT (AosTCPServices.Agent)
    VAR len, res: LONGINT;
    buf: ARRAY EchoBufSize OF CHAR;
    (* body creates a new process for each instance *)
  BEGIN {ACTIVE}
    ...
```

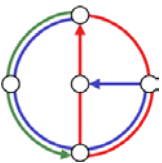

## TCP Server in Active Oberon (2)



```
BEGIN {ACTIVE}
  LOOP
    client.Receive(buf, 0, LEN(buf), 1, len, res);
    IF res # 0 THEN EXIT END; (*abort if reading failes*)
    client.Send(buf, 0, len, FALSE, res);
    IF res # 0 THEN EXIT END; (*abort if writing failes*)
  END;
  Terminate (*terminate the agent*)
END EchoAgent;

VAR echo: AostTCPServices.Service;
PROCEDURE Open*(par: PTR): PTR;
BEGIN (* Open a new service on the EchoPort. *)
  AostTCPServices.OpenService(echo, EchoPort, NewEchoAgent);
  (* NewEchoAgent is procedure to be called whenever
  a connection is made to the port *)
  RETURN NIL
END Open;
```

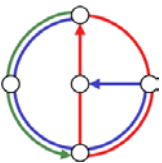

## TCP Server in Active Oberon (3)



```
PROCEDURE Close*(par: PTR): PTR;  
BEGIN (* close the service *)  
  AostTCPServices.CloseService(echo);  
  RETURN NIL  
END Close;  
  
PROCEDURE NewEchoAgent(c: AostTCP.Connection; s:  
AostTCPServices.Service): AostTCPServices.Agent;  
VAR a: EchoAgent;  
BEGIN (* Create a new agent of type EchoAgent *)  
  NEW(a, c, s); RETURN a  
END NewEchoAgent;  
  
PROCEDURE Cleanup;  
BEGIN (* Cleanup handler; invoked if module is unloaded *)  
  IF Close(NIL) = NIL THEN END  
END Cleanup;  
  
BEGIN (* install termination handler *)  
  AosModules.InstallTermHandler(Cleanup)  
END EchoServer.
```

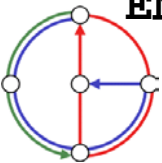

# Networking Examples in Active Oberon



- The source code of all the networking code is available and installed. The following list of modules is particularly interesting:
- Aos3Com90x.Mod, AosRTL8139.Mod: low level hardware drivers
- AosIP.Mod: implements IP
- AosTCP.Mod: implements TCP
- AosTCPServices.Mod: implements an abstract TCP service
- AosTestServer.Mod
  - implements RFC 862 (Echo), RFC 863 (Discard), RFC 864 (Chargen) and RFC 867 (Daytime)
- AosQuoteServer.Mod: implements RFC865 (Quote of the day)
- WebFTPServer.Mod: implements a FTP server
- WebHTTPServer.Mod: implements a HTTP1.1 server
- AosHTTPServer.Mod: implements a basic HTTP/1.0 server
- AosSMTPClient.Mod: implements RFC 862 (SMTP client)

